

# Preisliste

Price list · Tarif · Lista de precios · Prijslijst



**TURNUS**



**1919 - 2009**  
90 years of innovation

**W-409**

**i Info**



# www.KUKKO.com

**NEU ab Sommer 2009!**



Das KUKKO®  
"Abzieher-ABC-Video"  
für Messen, Homepages  
und Anwenderschulung

The KUKKO®  
"ABC for pulling-tools-video"  
for fairs, homepages and  
training



## KUKKO und TURNUS Quality System DIN EN ISO 9001:2008

Die Orientierung an diesem Leitbild ist eine Säule des Qualitätskonzeptes der Kleinbongartz & Kaiser oHG, sowie Eduard Gottfried Ferne GmbH & Co KG. Dieser Anspruch an uns selbst und unsere Produkte wird durch das Qualitätsmanagementsystem nach DIN EN ISO 9001:2008 ergänzt.

Nachdem KUKKO und TURNUS bereits im Jahre 1995 erstzertifiziert wurden folgten seitdem mehrere Wiederholaudits.

Diese bestätigten das kontinuierliche Qualitätsmanagement der Firmen Kleinbongartz & Kaiser oHG sowie der Eduard Gottfried Ferne GmbH & Co KG.



# Legende legend légende

info@KUKKO.com  
www.KUKKO.com

i Info 



**ST** = Standard-Programm

**HY** = Hydraulik-Programm

**NE** = Aktions-Programm

**Art.-No.** Neue Artikel erkennen Sie an den gelbmarkierten Artikelnummern und dem **NEU·NEW** - Stempel im Bild.

**Art.-No.-AT** das alte Originalstück wird gegen ein gebrauchtes, aber komplett repariertes, mit AT gelasertes Teil, ausgetauscht.



Unter der angegebenen Seitenzahl finden Sie den Artikel im Katalog D-01.



**Aktionspreis!**

Produktaufwertung!  
Technical innovation!

Die gekennzeichneten Produkte wurden überarbeitet und in der Ausführung verbessert.



**Der Neue!**  
**KUKKO / TURNUS**  
ab Herbst 2009!



## Produktion

KUKKO-Werkzeugfabrik  
Kleinbongartz & Kaiser oHG

Herderstrasse 10  
D-42853 Remscheid

Telefon: +49 (0) 21 91 / 93 39-0

Fax: +49 (0) 21 91 / 93 39-500



## Logistik-, Vertriebs- und Schulungszentrum

KUKKO-Werkzeugfabrik  
Kleinbongartz & Kaiser oHG

Taubenstrasse 5  
D-42857 Remscheid

Telefon: +49 (0) 21 91 / 93 39-0

Fax-Inland: +49 (0) 21 91 / 93 39-100

Fax-Export: +49 (0) 21 91 / 93 39-200

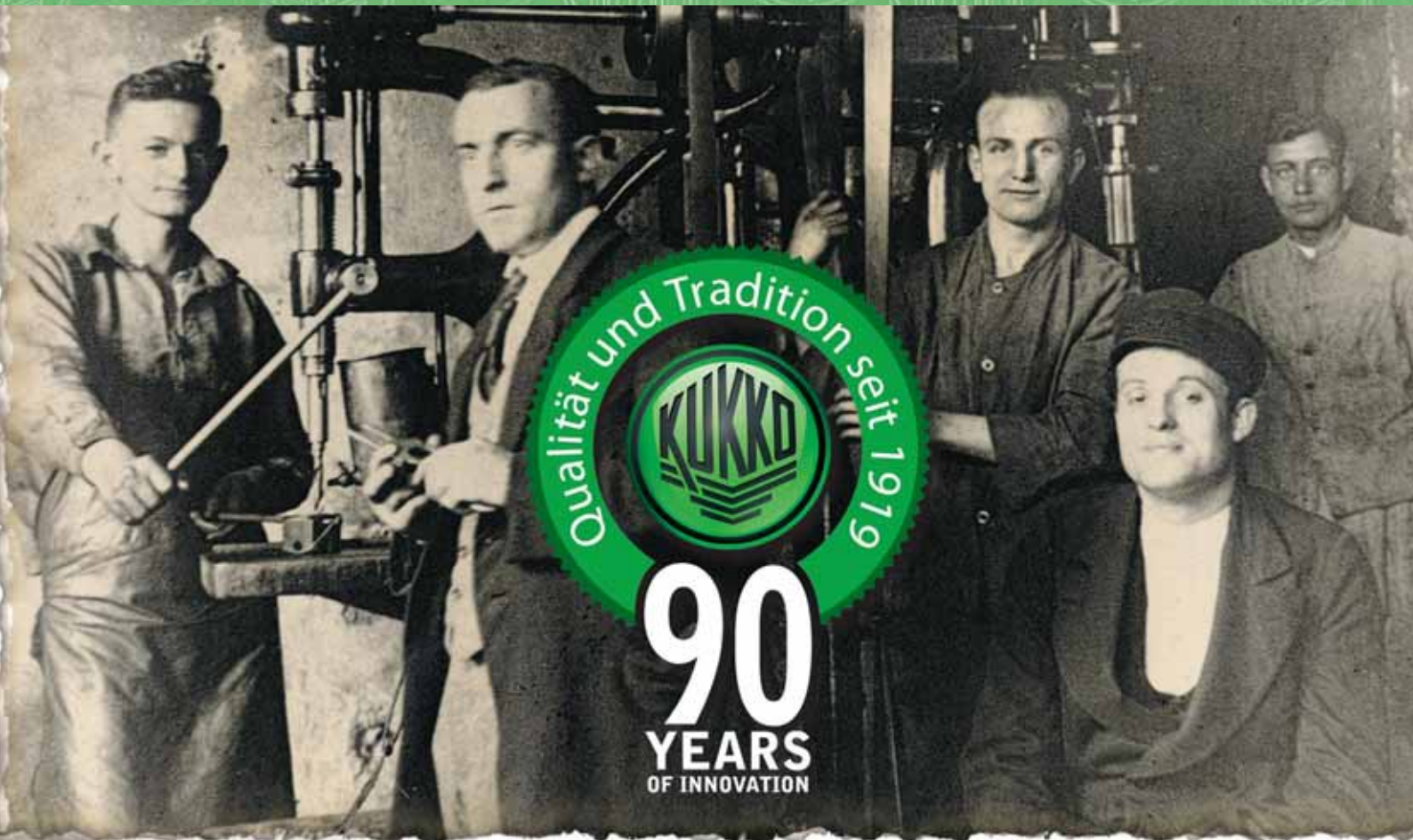

Die Firma **Kleinbongartz & Kaiser oHG** wurde von Alfred Kleinbongartz und seinem Schwager Emil Kaiser im Jahre 1919 gegründet und wird noch heute als, im Familienbesitz befindliche, Personengesellschaft geführt. Aus den Initialen der Gründer leitet sich der Markenname **KUKKO** ab.

Die Gründer beschäftigten sich mit der Problematik, festsitzende Teile von Maschinen, Motoren oder Wellen zu lösen ohne dabei Beschädigungen an den wiederverwendbaren Teilen zu verursachen. Durch die schnell voranschreitende Industrialisierung Anfang des 20. Jahrhunderts entstand immer mehr Bedarf an Abziehwerkzeugen der Firma **KUKKO**.

„Gib mir mal einen **KUKKO**“, sagen Mechaniker, wenn sie einen „Abzieher“ benötigen. Die Markenartikel werden in mehr als 160 Ländern vertrieben. **KUKKO** produziert am Standort Remscheid mit über 150 Mitarbeitern. Werkstvertretungen gibt es in Polen und den Niederlanden. Die Angebote der Unternehmensgruppe reichen von der Konstruktion und Fertigung von Werkzeugen bis zu Komplettlösungen für den Servicebereich. **KUKKO** Artikel werden in den Reparaturleitfäden von Volkswagen, Audi, Porsche, Seat, Skoda, Daimler Chrysler, BMW usw. genannt.

Heute ist der Name **KUKKO** rund um den Globus zum Synonym für Abziehwerkzeuge geworden. Das weltweit größte Komplettprogramm, welches alle möglichen Problemstellungen in Industrie Handwerk, Automobilbetrieben, Luft- und Raumfahrt abdeckt, ist das Ergebnis ständiger innovativer Weiterentwicklungen, in der Tradition der Gründer unseres Hauses.

1995 wurde **KUKKO** nach DIN EN ISO 9001 erstzertifiziert, seitdem folgten mehrere Wiederholaudits. Diese dokumentieren das kontinuierliche Qualitätsmanagement der Firma Kleinbongartz & Kaiser oHG.

Im Jahre 1998 wurde die Firma Eduard Gottfr. Ferne GmbH & Co. KG, deren Artikel unter den Markennamen **TURNUS** und **WINKELGREIF** bekannt sind, ein Teil des **KUKKO**-Firmenverbunds. Die Produktpalette wurde damit um Schraubzwingen und Feilkloben erweitert. 2003 und 2005 wurde das Produktportfolio durch die Groote Schlagwerkzeuge und die HSW Schraubendreher und Kunststoffspritzteile (Heinz Schlieper Werkzeuge GmbH) weiter ausgebaut.





### **KUKKO ORIGINAL Security Label**

Um Kunden vor minderwertigen Plagiaten und Produktpiraterie zu schützen werden KUKKO Werkzeuge ab sofort mit dem fälschungssicheren und patentierten KUKKO ORIGINAL Security Label versehen.



#### **Farbkipp-Effekt**

Beim Kippen des Security Labels ändert sich dessen Farbe von Weiss nach Cyan. Der grüne Logodruck verändert seine Farbe jedoch nicht.



#### **Hintergrund Prägung**

Die Prägung mit KUKKO Logo und dem Schriftzug "KUKKO" ist erhaben und ändert ebenfalls ihre Farbe beim Kippen des Security Labels. Hier jedoch von Rotgold nach Blau.



#### **Brüchiger Hintergrund**

Um zu vermeiden, dass ORIGINAL KUKKO Security Label auf Plagiaten angebracht werden, besitzen die Labels einen brüchigen Hintergrund. Beim Ablösen vom ORIGINAL KUKKO-Werkzeug wird das Label beschädigt.





**i Info**



# KUKKO-Technology

**AUTOGRIP**  
TECHNOLOGY

Automatische **Selbstspannung**, **Selbstverriegelung** und **Selbstzentrierung** der Abzughaken.

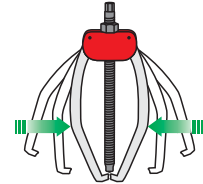

**easyScrew**<sup>®</sup>  
TECHNOLOGY

**Leichtes Betätigen** der Gegenstützen-Mutter durch **eingebautes Drucklager**. Der Reibungswiderstand wird auf ein Minimum reduziert.



**Glide & FIX**<sup>®</sup>  
TECHNOLOGY

**Gute Laufeigenschaft und Fixierung der Haken** auf der Traverse durch die neue **Glide & FIX**-Technologie.



**hydraulic**  
TECHNOLOGY

Werkzeuge mit **Hydraulik-Funktion**.



**LightSHIFT**<sup>®</sup>  
TECHNOLOGY

**Leichtgängig, verstellbare Haken** durch innenliegende **Federung**.



**Pullback**<sup>®</sup>  
TECHNOLOGY

**Leichtes Rückziehen** des Meißels aus der **gesprengten Mutter** durch die **Pull-back**-Technologie. **Kein Hängenbleiben**.

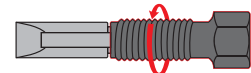

**SOLIDLOCK**<sup>®</sup>  
TECHNOLOGY

Durch die neue **SOLID-LOCK**-Technologie wird gewährleistet, dass die Haken **kein Spiel** mehr haben und so wird verhindert, dass der Abzieher vom abzuziehenden Teil abrutscht.



**QUICK adjust**<sup>®</sup>  
TECHNOLOGY

Ermöglicht durch die **Handstellrändel** ein **schnelles Lösen und Verschieben** der Abzughaken ohne Schraubenschlüssel.





# KUKKO-Abziehanleitung

## Puller instruction

### Instrucion de l'extracteur

#### Aussen-Abziehen

Outside pulling  
Extraction avec prise extérieure

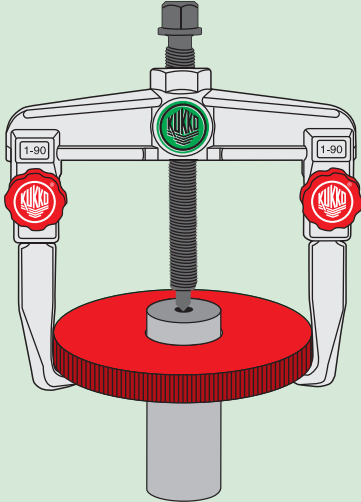

#### Innen-Ausziehen

Inside pulling  
Extraction avec prise intérieure

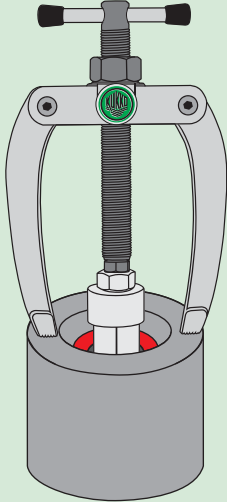

#### Trenn-Abziehen

Separating  
Décollage

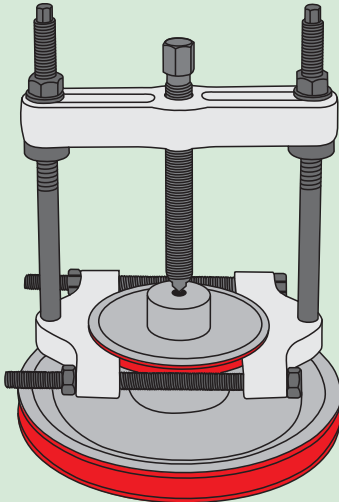



**i Info**



# Innovation, Baureihe 20

## Innovation, series 20

## Innovation, série 20

KUKKO  
das  
ORIGINAL!



Mit Artikelnummer  
gelaserter  
Spindelkopf



Abrutschsicherung!  
Kein Abrutschen der  
Schraubenschlüssel  
beim Abziehvorgang

**SOLID LOCK**<sup>®</sup>  
TECHNOLOGY

Durch die neue **SOLID-LOCK**-  
Technologie wird gewährleistet,  
dass die Haken kein Spiel mehr  
haben und so wird verhindert,  
dass der Abzieher vom ab-  
zuziehenden Teil abrutscht.

Der 6-Kant-Kopf  
der Traverse  
ermöglicht  
das Gegenhalten  
ungewünschter  
Drehungen

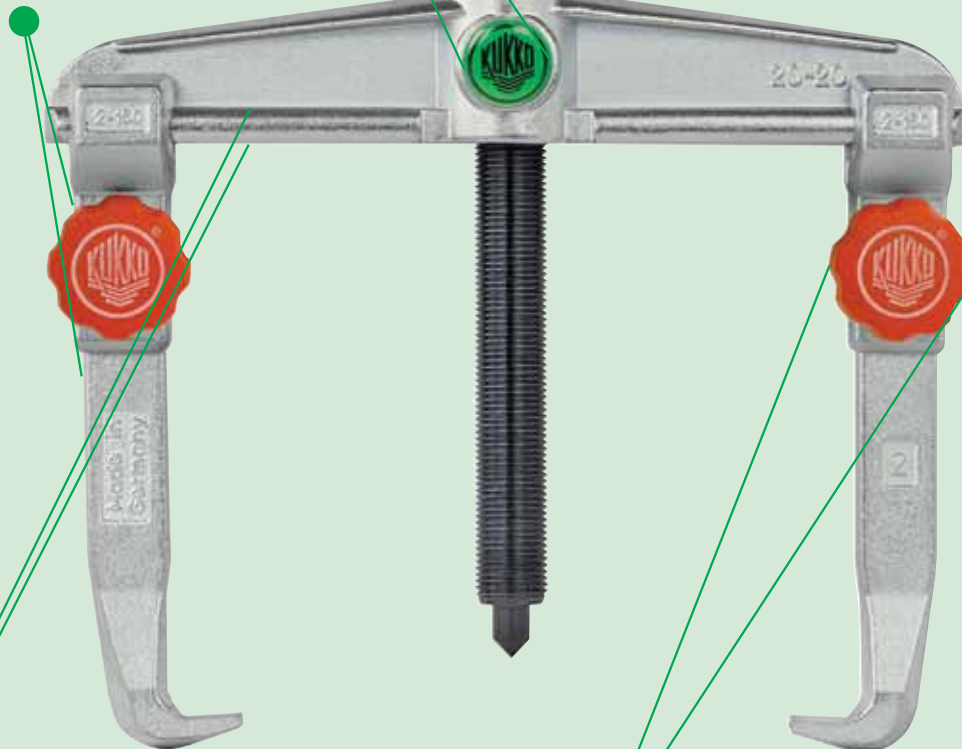

**Glide & FIX**<sup>®</sup>  
TECHNOLOGY

Gute Laufeigenschaft und Fixierung  
der Haken auf der Traverse durch  
die neue **Glide & FIX** Technologie

**QUICK adjust**<sup>®</sup>  
TECHNOLOGY

ermöglicht durch die Handstellränder  
ein schnelles Lösen und Verschieben  
der Abzughaken ohne Schrauben-  
schlüssel





# Innovation, Baureihe 22

## Innovation, series 22

## Innovation, série 22



**easyScrew®**  
TECHNOLOGY

Leichtes Abziehen durch das in die Traverse integrierte Drucklager, dass den Reibungswiderstand minimiert

**KUKKO das ORIGINAL!**

Keine Verletzungsgefahr durch eingelassene Schrauben

**LightSHIFT®**  
TECHNOLOGY

Leichtgängig, verstellbare Haken





## Standard Abziehwerkzeug-Programm

Pulling and extracting tool series  
Programme d'outillage d'extraction  
Programa de herramientas de extracción  
Trekgereedschappen programma

### 8 Hydraulische Spindeln

Hydraulic screws  
Vis hydrauliques  
Husillos hidráulicos  
Hydraulische spindeln



8-01 (G 1/2")  
8-02 (G 3/4")

10 + 12 to  
**hydraulic**  
TECHNOLOGY

9 ST	EAN-Code	Art.-No.	passend zu suitable for/s'adaptant à	to / KN		Euro
	4021176-887871	8-01	12-4, 12-5, 18-2, 20-2, 20-20 30-2, 30-20, 41-5, 42-5 205-02, 206-02, 207-02 u.v.A./and many others	10/100	1	216,30
	-887888	8-01ERS	No. 8-01		1	74,60
	-887895	8-01-AT	No. 8-01		1	119,80
	-887901	8-02	12-6, 12-7, 18-3, 20-3, 20-30 30-3, 205-1, 205-2, 205-3, 206-1, 206-2, 206-3, 207-1, 207-3, 207-2 u.v.A./and many others	12/120	1	247,20
	-887918	8-02ERS	No. 8-01		1	74,60
	-887925	8-02-AT	No. 8-02		1	127,80

### 8 Hydraulische Spindeln

Hydraulic screws  
Vis hydrauliques  
Husillos hidráulicos  
Hydraulische spindeln

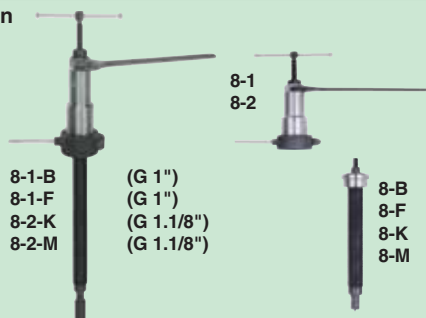

15 + 20 to  
**hydraulic**  
TECHNOLOGY

9 ST	EAN-Code	Art.-No.	passend zu suitable for/s'adaptant à	to / KN		Euro
	-034596	8-1-B	No. 11-0, 18-4, 20-4, 20-40	15/150	1	489,10
	-034671	8-1-F	No. 46-1, 46-2, 47-1, 47-2	15/150	1	505,40
	-034428	8-1		15/150	1	381,60
	-034183	8-B	+ 8-1 = 8-1-B		1	115,80
	-034268	8-F	+ 8-1 = 8-1-F		1	131,40
	-243721	8-1-ERS	No. 8-1		1	127,40
	-237478	8-1-AT	No. 8-1		1	184,40
19 ST	-034831	8-2-K	No. 11-1, 11-2	20/200	1	602,60
	-034916	8-2-M	No. 18-5, 20-5	20/200	1	695,20
	-034756	8-2		20/200	1	479,00
	-035098	8-K	+ 8-2 = 8-2-K		1	247,40
	-035173	8-M	+ 8-2 = 8-2-M		1	170,00
	-243806	8-2-ERS	No. 8-2		1	139,20
	-237546	8-2-AT	No. 8-2		1	207,10

### 9 Hydr. Zusatzpresse

Auxiliary hydr. ram  
Presse hydr. auxiliaire  
Prensa hidr. auxiliar  
Hydraulische hulppersen

10 + 15 to  
**hydraulic**  
TECHNOLOGY



19 ST	EAN-Code	Art.-No.	Hub/stroke/course	to/KN		Euro
	4021176-005053	9-1	10 mm	10/100	1	149,90
	-005138	9-2	15 mm	15/150	1	177,80
	-243981	9-1-ERS	No. 9-1		1	104,60
	-237621	9-1-AT	No. 9-1		1	118,20
	-244063	9-2-ERS	No. 9-2		1	115,50
	-237706	9-2-AT	No. 9-2		1	123,60

### 9 Hydr. Zusatzpresse

Auxiliary hydr. ram  
Presse hydr. auxiliaire  
Prensa hidr. auxiliar  
Hydraulische hulppersen

**Pullback**  
TECHNOLOGY



30 to  
**hydraulic**  
TECHNOLOGY



ST	EAN-Code	Art.-No.	Hub/stroke mm	h mm	Ø mm	to/KN		Euro
	4021176-924408	9-3	7	113	80	30	1	460,70

### 10-A Hydr. Radnabenabzieher

Hydr. hub puller  
Arrache-moyeux hydraulique  
Extractor hidráulico para cubos  
Hydraulische wielnaaftrekkers



20 to  
**hydraulic**  
TECHNOLOGY

68 ST	EAN-Code	Art.-No.	Ø - mm			Euro
	4021176-005626	10-A	250	6	1	926,80
	-005701	10-G	350	7	1	1235,80
	-005213	10-1	Zubehör/Accessories		1	395,50
	-005398	10-3	Zubehör/Accessories		1	231,90
	-005473	10-5	Zubehör/Accessories		1	333,40
	-005541	10-6	Zubehör/Accessories		1	71,70
	-244148	10-ERS	No. 10		1	164,00
	-237881	10-AT	No. 10		1	191,00

### 10-M Radnabenabzieher

Hub puller  
Arrache-moyeux  
Extractor para cubos  
Wielnaaftrekker



68 ST	EAN-Code	Art.-No.	Ø - mm		Euro
	4021176-862311	10-M	350	1	706,70

### 11-A 3-armige Abzieher

3-arm pullers  
Extracteurs à 3 bras  
Extractores de 3 brazos  
3-armige trekkers



16 ST	EAN-Code	Art.-No.	mm	mm		Euro
	4021176-005886	11-0-A	375	200	1	656,70
	-729263	11-0-A3	375	300	1	718,40
	-729348	11-0-A4	375	400	1	772,40
	-729423	11-0-A5	375	500	1	826,40
	-075421	11-1-A	520	200	1	892,00
	-729591	11-1-A3	520	300	1	952,00
	-729676	11-1-A4	520	400	1	1002,30
	-729751	11-1-A5	520	500	1	1029,00
	-006203	11-2-A	650	200	1	936,00
	-706158	11-2-A3	650	300	1	996,40
	-729836	11-2-A4	650	400	1	1047,40
	-729911	11-2-A5	650	500	1	1112,30





### 11-AV 3-armige Abzieher



3-arm pullers  
Extracteurs à 3 bras  
Extractores de 3 brazos  
3-armige trekkers

mit verstellbarer Spanntiefe  
with adjustable reach  
avec profondeur réglable  
con profundidad regulable  
met verstelbare spandiepte



16	EAN-Code	Art.-No.	 mm	 mm		Euro
ST	4021176-730078	11-0-AV	375	300-500	1	965,50
	-730153	11-1-AV	520	300-500	1	1204,80
	-730238	11-2-AV	650	300-500	1	1251,40



### 11-B 3-armige Abzieher

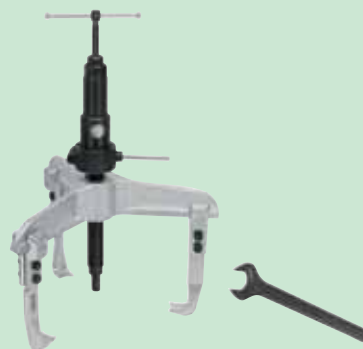

3-arm pullers  
Extracteurs à 3 bras  
Extractores de 3 brazos  
3-armige trekkers

15 + 20 to  
**hydraulic**  
TECHNOLOGY



17	EAN-Code	Art.-No.	 mm	 mm	to		Euro
ST	4021176-075346	11-0-B	375	200	15	1	1097,00
	-006128	11-1-B	520	200	20	1	1374,80
	-006388	11-2-B	650	200	20	1	1467,60
	-706073	11-3-B	650	300	20	1	1537,00

### 11-BV 3-armige Abzieher





3-arm pullers  
Extracteurs à 3 bras  
Extractores de 3 brazos  
3-armige trekkers

15 + 20 to  
**hydraulic**  
TECHNOLOGY





mit verstellbarer Spanntiefe  
with adjustable reach  
avec profondeur réglable  
con profundidad regulable  
met verstelbare spandiepte

17	EAN-Code	Art.-No.	 mm	 mm	to		Euro
ST	4021176-730313	11-0-BV	375	300-500	15	1	1421,20
	-730498	11-1-BV	520	300-500	20	1	1822,70
	-730566	11-2-BV	650	300-500	20	1	1853,80

### x-xx0-S Abzughaken

Pulling arms  
Griffes d'extraction  
Garras de extracción  
Trekhaken



17	EAN-Code	Art.-No.	passend zu suitable for/s'adaptant à	 mm		Euro
ST	4021176-003318	3-200-S	11-0, 11-1, 11-2, 30-3	200	1	194,70
	-003646	3-300-S	11-0, 11-1, 11-2, 30-3	300	1	250,20
	-003981	3-400-S	11-0, 11-1, 11-2, 30-3	400	1	301,40
	-004223	3-500-S	11-0, 11-1, 11-2, 30-3	500	1	315,10
	-004711	4-SP-S	11-0, 11-1, 11-2, 30-3	300-500	1	509,90

### 8/11

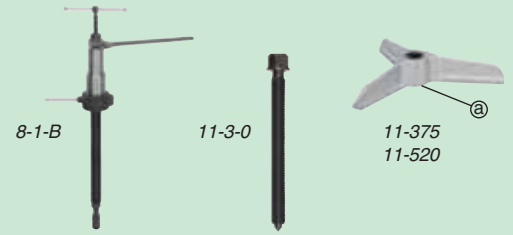





18	EAN-Code	Art.-No.	Teile für parts for/pièces pour/delen voor		Euro
ST	4021176-034596	8-1-B	No. 11-0	1	489,10
	-034831	8-2-K	No. 11-1, 11-2	1	602,60
	-169564	11-3-0	No. 11-0	1	75,20
	-126178	11-3-1	No. 11-1, 11-2	1	112,80
	-035258	11-375	No. 11-0	1	401,80
	-035333	11-520	No. 11-1	1	595,80
	-035418	11-650	No. 11-2	1	639,90
	-184734	01100120	@ Büchse/bush/douille 11-0	1	PG 5
	-184819	02005120	@ Büchse/bush/douille 11-1/11-2	1	PG 6

### 12 3-armiger Abzieher „Aligator“

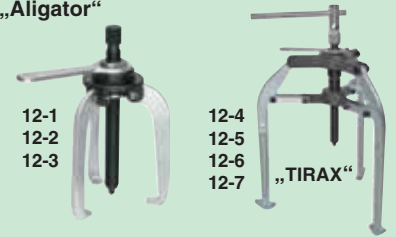

3-arm puller  
Extracteur à 3 bras  
Extractor de 3 brazos  
3-armige trekkers  
voreinstellbar  
preselectable  
préréglable  
preajustable  
vooraf instelbaar





22	EAN-Code	Art.-No.	 mm	 mm		Euro
ST	4021176-006616	12-1	100	100	1	116,00
	-006791	12-2	150	125	1	170,00
	-006876	12-3	200	180	1	247,20
	-850509	12-4	250	225	1	860,00
	-850684	12-5	350	275	1	1486,80
	-850769	12-6	450	300	1	1668,30
	-850844	12-7	650	350	1	2039,10

### 13 Keilriemenscheiben-Abzieher

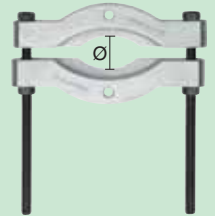

V-belt pulley puller  
Extracteur de poulies à gorges  
Extractor de poleas trapezoidales  
Riemschijftrekkers



54	EAN-Code	Art.-No.	passend zu suitable for/s'adaptant à	Ø mm		Euro
ST	4021176-169724	13-2	No. 18-2	40-150	1	133,00
	-169809	13-3	No. 18-3	50-250	1	324,40

### 14 Abzieher mit Krallenfüßen





Pullers with scissor-action arms  
Extracteurs à pieds-crampons  
Extractores con patas puntiagudas  
Trekkers met puntige klauwen

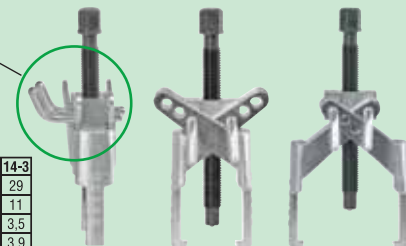

Schnellverstellung  
Quick-adjusting  
à réglage rapide  
regulación rápida  
snelverstelling



24	EAN-Code	Art.-No.	 mm	 mm		Euro
ST	4021176-459559	14-01	6-100	85	11	123,60
	-460111	14-03	15-140	160	12	185,40
	-455421	14-1	6-100	85	21	108,30
	-248443	14-2	10-140	125	29	139,20
	-248511	14-3	15-140	160	29	151,40



# INFOBOX: No. 15 · 17 · 18 · 19

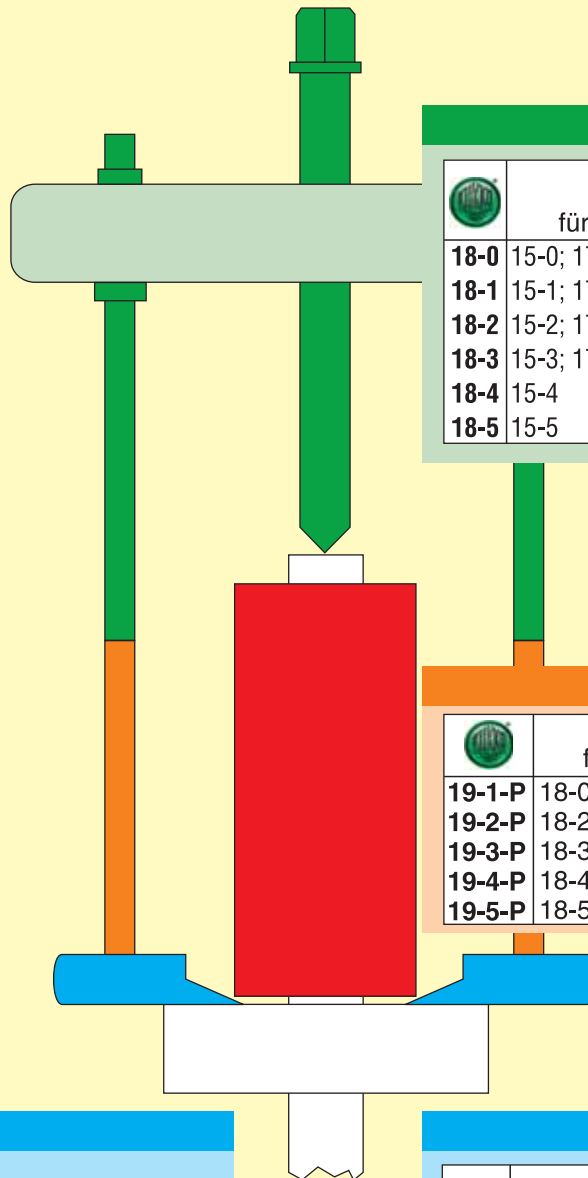

**18**

	für	A mm	L mm
18-0	15-0; 17-0	50-110	150
18-1	15-1; 17-1	60-150	200
18-2	15-2; 17-2	60-200	250
18-3	15-3; 17-3	80-300	300
18-4	15-4	120-380	350
18-5	15-5	150-440	400

**19**

	für	L mm
19-1-P	18-0; 18-1	100
19-2-P	18-2	100
19-3-P	18-3	100
19-4-P	18-4	200
19-5-P	18-5	200

**15**

	Ø mm	B mm
15-0	5- 60	60
15-1	12- 75	75
15-2	22-115	115
15-3	25-155	155
15-4	30-200	200
15-5	30-250	250

**17**

	Ø mm	B mm
17-0	5- 60	60
17-1	12- 75	75
17-2	22-115	115
17-3	25-155	155

## Sätze / Set / Jeux / Juegos

15-K	15-A	15-B	15-C	15-D	15-E
15-0	15-1	15-2	15-3	15-4	15-5
18-0	18-1	18-2	18-3	18-4	18-5
19-1-P	19-1-P	19-2-P	19-3-P	19-4-P	19-5-P



## Sätze / Set / Jeux / Juegos

17-K	17-A	17-B	17-C
17-0	17-1	17-2	17-3
18-0	18-1	18-2	18-3
19-1-P	19-1-P	19-2-P	19-3-P





## 15 Trennvorrichtungen

Separators  
D colleurs  
Separadores  
Mestrekkers

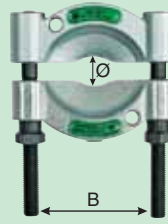

NEU · NEW

52	EAN-Code	Art.-No.	f�r for / pour	B mm	� mm		Euro
ST	4021176-006951	15-0	No. 18-0	60	5- 60	1	61,80
	-007033	15-1	No. 18-1	75	12- 75	1	81,10
	-007118	15-2	No. 18-2	115	22-115	1	123,60
	-007293	15-3	No. 18-3	155	25-155	1	201,00
	-007378	15-4	No. 18-4	200	30-200	1	509,90
	-007453	15-5	No. 18-5	250	30-250	1	710,70

## 17 Trennvorrichtungen

Separators  
D colleurs  
Separadores  
Mestrekkers

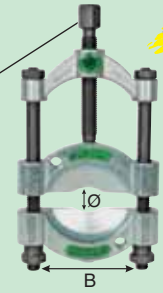

NEU · NEW

mit Schnellspannspindel  
with quick-action pressure screw  
avec vis de serrage rapide  
con sujeci n r pida  
met snelspan-spindel

52	EAN-Code	Art.-No.	f�r for / pour	B mm	� mm		Euro
ST	4021176-008108	17-0	No. 18-0	60	5- 60	1	92,70
	-008283	17-1	No. 18-1	75	12- 75	1	119,80
	-008368	17-2	No. 18-2	115	22-115	1	174,60
	-008443	17-3	No. 18-3	155	25-155	1	270,30

## 15 Trennvorrichtungens tze

Separating-sets  
Jeux de d collage  
Juegos de separaci n  
Mestrekker-sets



NEU · NEW

53	EAN-Code	Art.-No.	Inhalt contents/contenu/inhoud	� mm		Euro
ST	4021176-007941	15-K	15-0, 18-0, 19-1-P	5- 60	1	173,10
	-007521	15-A	15-1, 18-1, 19-1-P	12- 75	1	231,90
	-007606	15-B	15-2, 18-2, 19-2-P	22-115	1	339,80
	-007781	15-C	15-3, 18-3, 19-3-P	25-155	1	509,90
	-007866	15-D	15-4, 18-4, 19-4-P	30-200	1	1220,40
	-308826	15-E	15-5, 18-5, 19-5-P	30-250	1	1560,30

## 17 Trennvorrichtungens tze

Separating-sets  
Jeux de d collage  
Juegos de separaci n  
Mestrekker-sets



NEU · NEW

mit Schnellspannspindel  
with quick-action pressure screw  
avec vis de serrage rapide  
con sujeci n r pida  
met snelspan-spindel

53	EAN-Code	Art.-No.	Inhalt contents/contenu/inhoud	� mm		Euro
ST	4021176-008856	17-K	17-0, 18-0, 19-1-P	5- 60	1	224,00
	-008511	17-A	17-1, 18-1, 19-1-P	12- 75	1	259,60
	-008696	17-B	17-2, 18-2, 19-2-P	22-115	1	395,60
	-008771	17-C	17-3, 18-3, 19-3-P	25-155	1	590,30

## 16 Zylinderb chen-Auszieher

Cylinder liner puller  
Extracteur de chemises de cylindre  
Extractor de camisas de cilindro  
Cylinderbus-trekker



41	EAN-Code	Art.-No.	�-mm		Euro
ST	4021176-008023	16	60-155	1	505,80
	-251559	16-21	60-155	1	334,00
	-251634	16-22		1	243,40

## 18 Abziehvorrichtungen

Pulling devices  
Extracteurs   tirants  
Dispositivos extractores  
Hulptrekker

Produktaufwertung!  
Technical innovation!

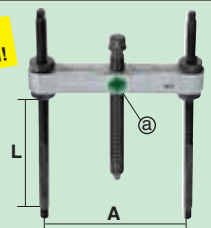

53	EAN-Code	Art.-No.	passend zu suitable for	A mm	L mm		Euro
ST	4021176-075599	18-0	No. 15-0, 17-0	50-110	71-150	1	55,60
	-075674	18-1	No. 15-1, 17-1	60-150	122-200	1	92,70
	-075759	18-2	No. 13-2, 15-2, 17-2	60-200	125-250	1	135,20
	-005961	18-3	No. 13-3, 15-3, 17-3	80-300	144-302	1	216,30
	-006043	18-4	No. 15-4	120-380	134-350	1	463,50
	-075834	18-5	No. 15-5	150-440	225-400	1	679,80
	-202551	01840120	@ B�chse/bush 18-4			1	PG 3
	-202711	01850120	@ B�chse/bush 18-5			1	PG 4
	-914591	18-3-BPW	siehe/look WT-030			1	895,90
	-465246	18-4SAF	siehe/look WT-031			1	843,20

## 16 Zylinderb chen-Auszieher-Satz

Cylinder liner puller set  
Jeu de extracteur de chemises de cylindre  
Juego de extractor de camisas de cilindro  
Cylinderbus-trekker set



41	EAN-Code	Art.-No.	Inhalt contents/contenu/inhoud	�-mm		Euro
ST	4021176-392144	16-K	16-21, 16-22	60-155	1	610,20





### 18-B Abziehvorrichtungen

— Pulling devices  
 Extracteurs à tirants  
 Dispositivos extractores  
 Hulptrekkers

**7+10+15+20 to**  
**hydraulic**  
 TECHNOLOGY



EAN-Code	Art.-No.	passend zu suitable for/s'adaptant à	to/KN	with with/avec		Euro
4021176-885723	18-2-B	No. 13-2, 15-2, 17-2	7/70	8-01	1	351,60
-885730	18-3-B	No. 13-3, 15-3, 17-3	10/100	8-02	1	474,60
-885747	18-4-B	No. 15-4	15/150	8-1-B	1	1032,60
-885754	18-5-B	No. 15-5	20/200	8-2-M	1	1429,80

### 19 Verlängerungen

Extensions  
 Rallonges  
 Alargaderas  
 Verlengstukken

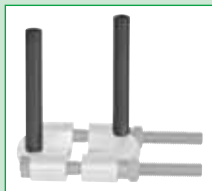

Paar/pair/paire

EAN-Code	Art.-No.	passend zu / suitable for s'adaptant à / geschikt voor	L mm		Euro
4021176-169984	19-1-P	No. 18-0+18-1	100	1	18,70
-170041	19-2-P	No. 18-2	100	1	23,20
-170126	19-3-P	No. 18-3	100	1	27,90
-168321	19-4-P	No. 18-4	200	1	46,40
-152306	19-5-P	No. 18-5	200	1	65,00

### 18-AS Gewindeadapter

Screw adapters  
 Adaptateurs  
 Adaptadores  
 Schroefdraadadapters

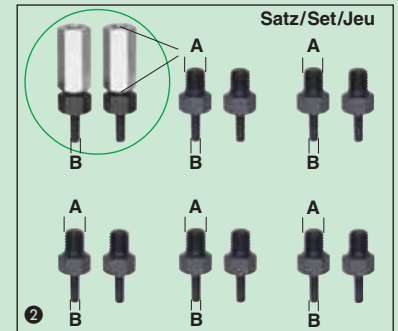

EAN-Code	Art.-No.	passend zu suitable for s'adaptant	Gewinde threads/files			Euro
4021176-337048	18-0-AS	18-0, 18-1	M4-M5-M6-M8-M10-M12		2	104,20
-788406	18-003A	18-0, 18-1	B = M 3	A = M 10	1	22,80
-337383	18-004A	18-0, 18-1	B = M 4	A = M 10	1	22,40
-337468	18-005A	18-0, 18-1	B = M 5	A = M 10	1	22,40
-337536	18-006A	18-0, 18-1	B = M 6	A = M 10	1	30,70
-337611	18-008A	18-0, 18-1	B = M 8	A = M 10	1	23,80
-337796	18-010A	18-0, 18-1	B = M10	A = M 10	1	23,80
-337871	18-012A	18-0, 18-1	B = M12	A = M 10	1	24,40
-788574	18-016A	18-0, 18-1	B = M16	A = M 10	1	29,60
-337123	18-2-AS	18-2	M8-M10-M12-M14-M16-M18		2	161,10
-337956	18-208A	18-2	B = M 8	A = M14x1,5	1	45,20
-338113	18-210A	18-2	B = M10	A = M14x1,5	1	45,90
-338298	18-212A	18-2	B = M12	A = M14x1,5	1	46,60
-338373	18-214A	18-2	B = M14	A = M14x1,5	1	47,60
-338458	18-216A	18-2	B = M16	A = M14x1,5	1	48,30
-338526	18-218A	18-2	B = M18	A = M14x1,5	1	49,40
-337208	18-3-AS	18-3	M14-M16-M18-M20-M22-M24		2	226,70
-338601	18-314A	18-3	B = M14	A = M18x1,5	1	65,40
-338786	18-316A	18-3	B = M16	A = M18x1,5	1	66,60
-338861	18-318A	18-3	B = M18	A = M18x1,5	1	67,10
-338946	18-320A	18-3	B = M20	A = M18x1,5	1	67,50
-339028	18-322A	18-3	B = M22	A = M18x1,5	1	68,70
-339103	18-324A	18-3	B = M24	A = M18x1,5	1	69,20



Bei großen Lagern  
 kann die Abziehv-  
 vorrichtung No. 18  
 durch die hydraul-  
 ische Versionen:  
 Y28-180  
 Y38-180  
 Y58-180  
 ersetzt werden.  
 Siehe Seite: 64



# INFOBOX: Innovation, Baureihe 20



KUKKO  
das  
ORIGINAL!



Mit Artikelnummer  
gelaserter  
Spindelkopf



Abrutschsicherung!  
Kein Abrutschen der  
Schraubenschlüssel  
beim Abziehvorgang

**SOLID LOCK**<sup>®</sup>  
TECHNOLOGY

Durch die neue **SOLID-LOCK**-  
Technologie wird gewährleistet,  
dass die Haken kein Spiel mehr  
haben und so wird verhindert,  
dass der Abzieher vom ab-  
ziehenden Teil abrutscht.

Der 6-Kant-Kopf  
der Traverse  
ermöglicht  
das Gegenhalten  
ungewünschter  
Drehungen

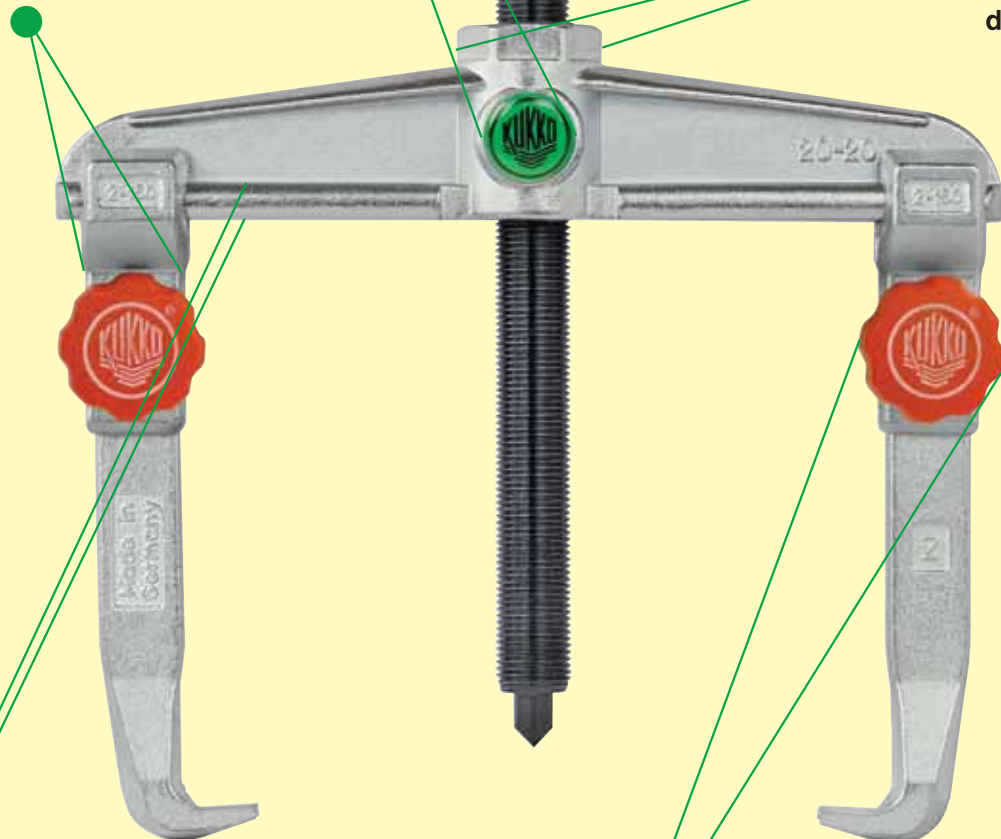

**Glide & FIX**<sup>®</sup>  
TECHNOLOGY

Gute Laufeigenschaft und Fixierung  
der Haken auf der Traverse durch  
die neue **Glide & FIX** Technologie

**Quick adjust**<sup>®</sup>  
TECHNOLOGY

ermöglicht durch die Handstellrändel  
ein schnelles Lösen und Verschieben  
der Abzughaken ohne Schrauben-  
schlüssel



## Lochtafeln, Serie 20 • Wall panel, series 20 • Panneau, série 20

### 30-20-T Universal-Abzieher-Satz auf Lochtafel

Universal puller set on wall panel  
 Jeu d'extracteurs universels sur panneau  
 Juego de extractores universales en panel mural  
 Universeel trekker-set op wandbord

*Satz/Set/Jeu*  
 14-teilig/parts  
 20-10, 20-10-2,  
 30-10, 30-10-2,  
 20-20, 20-20-3,  
 30-20, 30-20-3,  
 15-2, 699999



### WT-50 Universal-Abzieher-Satz auf Lochtafel

Universal puller set on wall panel  
 Jeu d'extracteurs universels sur panneau  
 Juego de extractores universales en panel mural  
 Universeel trekker-set op wandbord

*Satz/Set/Jeu*  
 16-teilig/parts  
 20-10+, 20-10-2+,  
 30-10+, 30-10-2+,  
 20-20+, 20-20-3+,  
 30-20+, 30-20-3+,  
 15-2, 9-1, 18-2,  
 699999



13	EAN-Code 4021176-	Art.-No.	mm	mm	mm	1	Euro
ST	-875717	30-20-T	0-200	100-300	22-115	1	795,50

13	EAN-Code 4021176-	Art.-No.	mm	mm	mm	1	Euro
ST	-951114	WT-50	0-200	100-300	22-115	1	855,00

### 20 2-armige Abzieher

2-arm pullers  
 Extracteurs à 2 bras  
 Extractores de 2 brazos  
 2-armige trekkers

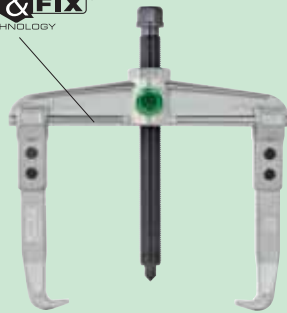

8	EAN-Code 4021176-	Art.-No.	mm	mm	1	Euro
ST	-009433	20-1	90	100	1	72,40
	-009921	20-10	120	100	1	78,20
	-009501	20-2	160	150	1	136,70
	-010088	20-20	200	150	1	148,60
	-009686	20-3	250	200	1	250,60
	-010163	20-30	350	200	1	273,00
	-009761	20-4	520	200	1	401,90
	-411861	20-40	650	300	1	730,00
	-009846	20-5	750	400-700	1	1650,00

### 20 2-armige Abzieher

2-arm pullers  
 Extracteurs à 2 bras  
 Extractores de 2 brazos  
 2-armige trekkers



*mit längeren Abzughaken  
 with extended pulling arms  
 avec griffes plus longues  
 con garras más largas  
 met verlengde trekhaken*

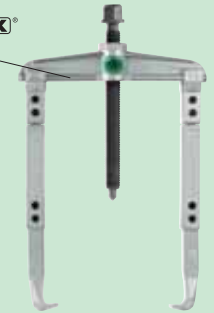

8	EAN-Code 4021176-	Art.-No.	mm	mm	1	Euro
ST	-466311	20-1-2	90	200	1	90,70
	-908675	20-1-25	90	250	1	104,60
	-989643	20-1-4	90	400	1	143,40
	-466496	20-10-2	120	200	1	96,20
	-908682	20-10-25	120	250	1	110,30
	-989650	20-10-4	120	400	1	149,20
	-466564	20-2-3	160	300	1	165,40
	-466649	20-20-3	200	300	1	177,20
	-901188	20-3-25	250	250	1	269,40
	-466724	20-3-3	250	300	1	289,10
	-467066	20-3-4	250	400	1	321,90
	-467301	20-3-5	250	500	1	331,80
	-466809	20-30-3	350	300	1	311,50
	-467141	20-30-4	350	400	1	344,00
	-467486	20-30-5	350	500	1	354,20
	-466984	20-4-3	520	300	1	441,00
	-467226	20-4-4	520	400	1	473,10
	-467554	20-4-5	520	500	1	483,00
	-730641	20-40-4	650	400	1	764,20
	-731976	20-40-5	650	500	1	773,10

### K-20-15 Universal Abzieh- und Trennvorrichtung-Satz

Universal puller set with separator  
 Jeu d'extracteurs universels avec décolleur  
 Juego de extractores y dispositivo extractor  
 Universeel trekker en mestrekker set



*Satz/Set/Jeu*  
 8-teilig/parts  
 20-1, 20-2,  
 1-190-P,  
 2-300-P,  
 15-2, 9-2



13	EAN-Code 4021176-	Art.-No.	mm	mm	mm	1	Euro
ST	-367311	K-20-15	90-160	100-150	22-115	1	849,80

**Problem:**  
 Die Abzughaken sind zu kurz und können so nicht um das abzuziehende Teil greifen.



**Lösung:**  
 Die KUKKO-Standardhaken werden demonstrierend und mit den Verlängerungen wieder zu zusammen montiert und mit den Verlängerungen ineinander montiert werden müssen hängt davon ab, wie tief das abzuziehende Teil sitzt. Das System läßt sich unendlich verlängern und kann so jeder Problemstellung gerecht werden.



Siehe auch Seiten 18-19





### 20-B 2-armige Abzieher

2-arm pullers  
Extracteurs à 2 bras  
Extractores de 2 brazos  
2-armige trekkers

7 + 10 + 15 to  
**hydraulic**  
TECHNOLOGY



ST	EAN-Code 4021176-	Art.-No.	mm	mm	to/KN	mit with/avec	Euro
	-885815	20-2-B	160	150	7/ 70	8-01	386,30
	-885846	20-20-B	200	150	7/ 70	8-01	401,80
	-885891	20-3-B	250	200	10/100	8-02	479,00
	-885945	20-30-B	350	200	10/100	8-02	488,20
	-885983	20-4-B	520	200	15/150	8-1-B	911,50
	-886010	20-40-B	650	300	15/150	8-1-B	1159,60

### 20-B 2-armige Abzieher

2-arm pullers  
Extracteurs à 2 bras  
Extractores de 2 brazos  
2-armige trekker

7 + 10 + 15 to  
**hydraulic**  
TECHNOLOGY



mit längeren Abzughaken  
with extended pulling arms  
avec griffes plus longues  
con garras más largas  
met verlengde trekhaken

ST	EAN-Code 4021176-	Art.-No.	mm	mm	to/KN	mit with/avec	Euro
	-885808	20-2-3-B	160	300	7/ 70	8-01	439,90
	-885839	20-20-3-B	200	300	7/ 70	8-01	448,00
	-885860	20-3-3-B	250	300	10/100	8-02	556,20
	-885877	20-3-4-B	250	400	10/100	8-02	579,20
	-885884	20-3-5-B	250	500	10/100	8-02	602,60
	-885914	20-30-3-B	350	300	10/100	8-02	568,40
	-885921	20-30-4-B	350	400	10/100	8-02	587,10
	-885938	20-30-5-B	350	500	10/100	8-02	621,10
	-885952	20-4-3-B	520	300	15/150	8-1-B	973,40
	-885969	20-4-4-B	520	400	15/150	8-1-B	996,40
	-885976	20-4-5-B	520	500	15/150	8-1-B	926,80
	-885990	20-40-4-B	650	400	15/150	8-1-B	1193,50
	-886003	20-40-5-B	650	500	15/150	8-1-B	1203,10

### 20-AV/20-5 2-armige Abzieher

2-arm pullers  
Extracteurs à 2 bras  
Extractores de 2 brazos  
2-armige trekkers

mit verstellbarer Spannweite  
with adjustable reach  
avec profondeur réglable  
con profundidad regulable  
met verstelbare spandiepte

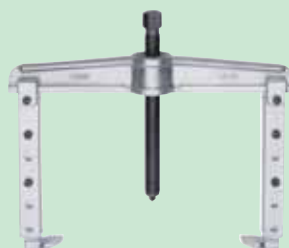

ST	EAN-Code 4021176-	Art.-No.	mm	mm	Euro
	-706233	20-4-AV	520	300-500	630,00
	-732058	20-40-AV	650	300-500	910,70
	-009846	20-5	750	400-700	1650,00

### 20-H 2-armige Abzieher

2-arm pullers  
Extracteurs à 2 bras  
Extractores de 2 brazos  
2-armige trekkers

10 to  
**hydraulic**  
TECHNOLOGY

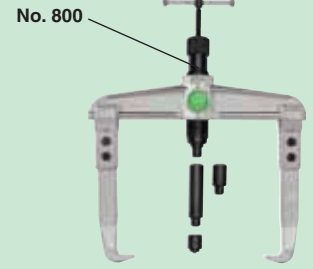

9	EAN-Code 4021176-	Art.-No.	mm	mm	Euro
ST	-786839	20-3-H	250	200	536,60
	-786914	20-30-H	350	200	572,80

### 20-H 2-armige Abzieher

2-arm pullers  
Extracteurs à 2 bras  
Extractores de 2 brazos  
2-armige trekkers

15 + 20 to  
**hydraulic**  
TECHNOLOGY

mit verstellbarer Spannweite  
with adjustable reach  
avec profondeur réglable  
con profundidad regulable  
met verstelbare spandiepte



9	EAN-Code 4021176-	Art.-No.	mm	mm	to/KN	mit with/avec	Euro
ST	-227981	20-4-H	520	300-500	15/150	8-1-B	1050,60
	-732218	20-40-H	650	300-500	15/150	8-1-B	1328,60
	-228063	20-5-H	750	400-700	20/200	8-2-M	2317,20

### 20-P3 2-armiger Abzieher

2-arm puller  
Extracteur à 2 bras  
Extractor de 2 brazos  
2-armige trekkers

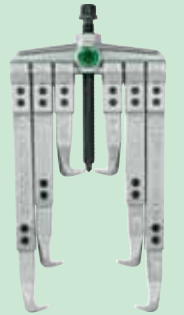

ST	EAN-Code 4021176-	Art.-No.	mm	mm	Euro
	-267611	20-10-P3	120	100-350	245,00
	-003005	20-20-P2	200	150/300	256,60
	-003012	20-30-P3	350	200/300/400	737,50

### K-2030-10 2- und 3-armiger Universalabzieher-Satz

Set of two- and three-arm pullers  
Jeu d'extracteurs universels à 2- et 3 bras  
Juego de extractores universales de 2 y 3 brazos  
2- en 3-armige universele trekkers-set

Inhalt / contents:  
20-10-P3 30-10-P3 614250



ST	EAN-Code 4021176-	Art.-No.	mm	mm	Euro
	-974748	K-2030-10	120	100-350	324,40

# INFOBOX: Verlängerungen / Extensions / Rallonges



**Problem:**  
Die Abzughaken sind zu kurz und können so nicht um das abzuziehende Teil greifen.



**Lösung:**  
Die KUKKO-Standardhaken werden demontiert und mit den Verlängerungen wieder zu zusammen montiert. Wie viele Verlängerungen in einander montiert werden müssen hängt davon ab, wie tief das abzuziehende Teil sitzt.  
**Das System lässt sich unendlich verlängern und kann so jeder Problemstellung gerecht werden.**

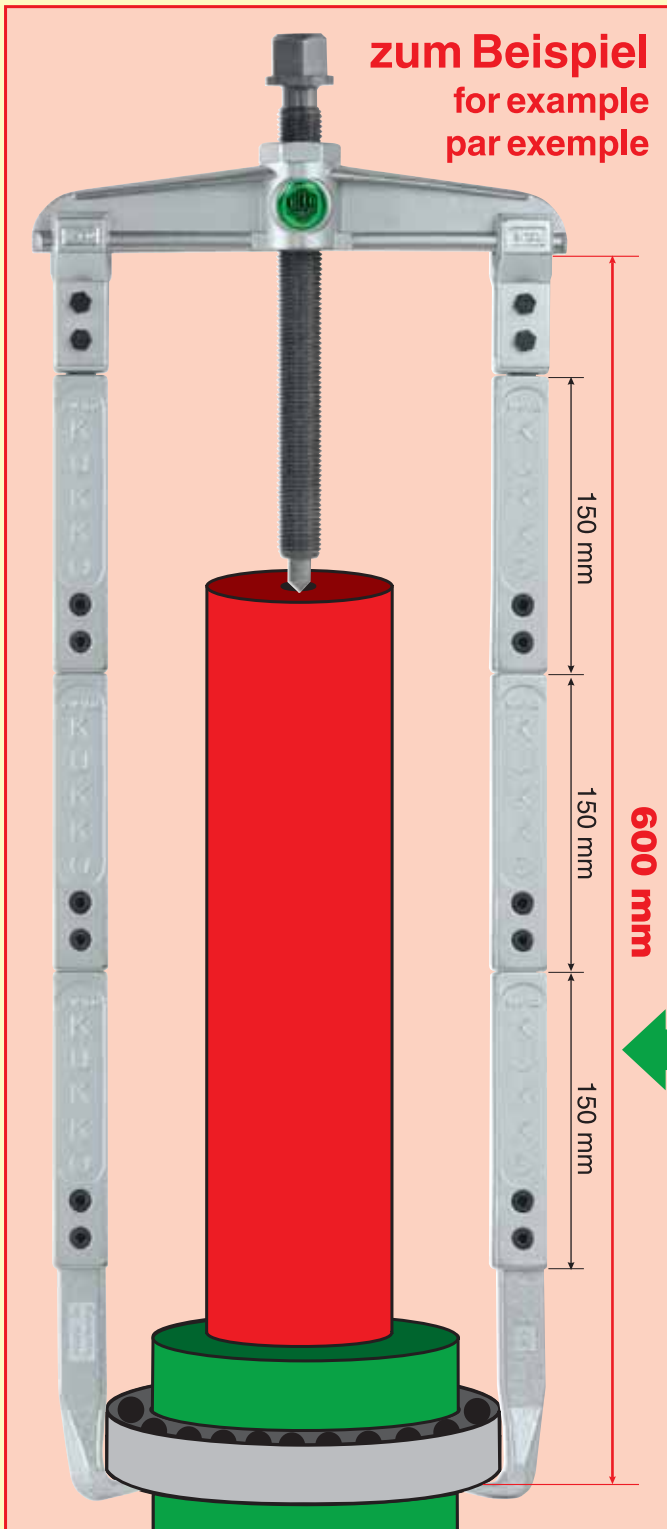

Druckpindel · pressure screw · vis de pression



+



+

Abzughaken · pulling arm · griffes d'extraction



=

20/30 Standard

Art.-No.	Length	Image
20-1	100 mm	
20-10	100 mm	
20-2	150 mm	
20-20	150 mm	
30-1	100 mm	
30-10	100 mm	
30-2	150 mm	
30-20	150 mm	

+

Verlängerungen · Extensions · Rallonges

150 mm - ∞	
20-1	20-2
20-10	20-20
30-1	30-2
30-10	30-20
+	
1-V-100	1-V-150
+	
2-V-150	

## 20-ST Verkaufs- und Werkstattständer

— Sales display and workshop stand  
Stand de vente et d'atelier  
Caballete de exhibición y de talleres  
Verkoop- en werkplaatsstandaard



10 ST	EAN-Code 4021176- -010248	Art.-No. 20-ST	Inhalt contents/contenu/inhoud 20-1, 20-10, 20-2, 20-20, 20-3		Euro
				1	685,40

## x-xx0-P 2 Abzughaken STANDARD

2 Pulling arms  
2 Griffes d'extraction  
2 Garras de extracción  
2 Trekhaken



8 ST	EAN-Code 4021176-	Art.-No.	für for/pour		mm		Euro
	-001338	1-90-P	20-1, 20-10		100	1	41,40
	-002403	2-150-P	20-2, 20-20		150	1	77,50
	-003233	3-200-P	20-3, 20-30, 20-4, 20-40		200	1	129,60
	-001666	1-190-P	20-1, 20-10		200	1	61,80
	-001901	1-250-P	20-1, 20-10		250	1	74,30
	-002731	2-300-P	20-2, 20-20		300	1	115,80
	-003561	3-300-P	20-3, 20-30, 20-4, 20-40		300	1	167,00
	-003806	3-400-P	20-3, 20-30, 20-4, 20-40		400	1	201,00
	-004148	3-500-P	20-3, 20-30, 20-4, 20-40		500	1	224,00

## Abzughaken

Pulling arms  
Griffes d'extraction  
Garras de extracción  
Trekhaken



10 ST	EAN-Code 4021176-	Art.-No.	für for/pour		Euro
	-047213	02001001	20-1, 20-10	1	PG 1
	-048616	02002001	20-2, 20-20	1	PG 2
	-049866	02003001	20-3, 20-30, 20-4, 20-40	1	PG 3

## x-V-xxx-P 2 Verlängerungen

2 Extensions  
2 Rallonges  
2 Alargaderas  
2 Verlengstukken



10 ST	EAN-Code 4021176-	Art.-No.	für for/pour	L mm		Euro
	-985058	1-V-100-P	20-1, 20-10	100	1	27,00
	-985089	1-V-150-P	20-1, 20-10	150	1	35,90
	-985201	2-V-150-P	20-2, 20-20	150	1	62,70

## x-SP-P 2 Abzughaken

2 Pulling arms mit verstellbarer Länge  
with adjustable length  
2 Griffes d'extraction réglables sur plusieurs longueurs  
2 Garras de extracción regulable a diversas longitudes  
2 Trekhaken in verschillende lengtes verstelbaar



9 ST	EAN-Code 4021176-	Art.-No.	für for/pour		mm		Euro
	-004636	4-SP-P	20-3, 20-30, 20-4, 20-40		300-500	1	339,80
	-004971	5-SP-P	20-5		400-700	1	710,70

## 20-S 2-armige Abzieher

— 2-arm pullers  
Extracteurs à 2 bras  
Extractores de 2 brazos  
2-armige trekkers

für enge Zwischenräume  
for confined spaces  
pour endroits exigus  
para intersticios angostos  
voor nauwe tussenruimtes



Extrem schmale Abzughaken!  
Extremely small pulling arms!



11 ST	EAN-Code 4021176-	Art.-No.		mm		mm		Euro
	-757396	20-1-S		90		100	1	91,00
	-757471	20-10-S		120		100	1	96,60
	-727368	20-2-S		160		150	1	171,10
	-727443	20-20-S		200		150	1	182,80
	-727511	20-3-S		250		200	1	307,10
	-727696	20-30-S		350		200	1	329,90

## 20-ST-S Verkaufs- und Werkstattständer

— Sales display and workshop stand  
Stand de vente et d'atelier  
Caballete de exhibición y de talleres  
Verkoop- en werkplaatsstandaard



Extrem schmale Abzughaken!  
Extremely small pulling arms!

für enge Zwischenräume  
for confined spaces  
pour endroits exigus  
para intersticios angostos  
voor nauwe tussenruimtes



10 ST	EAN-Code 4021176-	Art.-No.	Inhalt contents/contenu/inhoud		Euro
	-906282	20-ST-S	20-1-S, 20-10-S, 20-2-S, 20-20-S, 20-3-S	1	849,80

## 20-SP 2-armiger Abzieher

— 2-arm puller  
Extracteur à 2 bras  
Extractor de 2 brazos  
2-armige trekkers

für enge Zwischenräume  
for confined spaces  
pour endroits exigus  
para intersticios angostos  
voor nauwe tussenruimtes



Extrem schmale Abzughaken!  
Extremely small pulling arms!

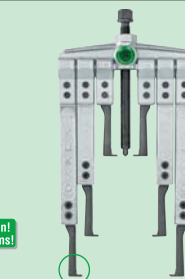

11 ST	EAN-Code 4021176-	Art.-No.		mm		mm		Euro
	-461514	20-10-SP		120		100-350	1	257,20
	-701856	20-20-SP		200		150/300	1	318,40
	-701931	20-30-SP		350		200/300/400	1	839,60

## K-2030-10-S 2- und 3-armiger Universalabzieher-Satz

— Set of two- and three-arm pullers  
Jeu d'extracteurs universels à 2- et 3 bras  
Juego de extractores universales de 2 y 3 brazos  
2- en 3-armige universele trekkers-set

Inhalt / contents:  
20-10-SP 30-10-SP 614250



für enge Zwischenräume  
for confined spaces  
pour interstices étroits  
para intersticios angostos  
voor nauwe tussenruimtes



Extrem schmale Abzughaken!  
Extremely small pulling arms!

11 ST	EAN-Code 4021176-	Art.-No.		mm		mm		Euro
	-306181	K-2030-10-S		120		100-350	1	477,40





### xxx1-P 2 Abzughaken

2 Pulling arms  
2 Griffes d'extraction  
2 Garras de extracción  
2 Trekhaken

für enge Zwischenräume  
for confined spaces  
pour endroits exigues  
para intersticios angostos  
voor nauwe tussenruimtes



Extrem schmale Abzughaken!  
Extremely small pulling arms!



### Abzughaken

Pulling arms  
Griffes d'extraction  
Garras de extracción  
Trekhaken



Extrem schmale Abzughaken!  
Extremely small pulling arms!



ST	EAN-Code 4021176-	Art.-No.	für for/pour		Euro
	-871221	02000025	20-1, 20-10	1	PG 1
	-871238	02002125	20-2, 20-20	1	PG 2
	-871245	02003225	20-3, 20-30	1	PG 3

11

ST

EAN-Code 4021176-	Art.-No.	für for/pour			Euro
-434716	1-91-P	20-1, 20-10	100	1	58,20
-461286	1-191-P	20-1, 20-10	200	1	72,40
-461446	1-251-P	20-1, 20-10	250	1	87,50
-985010	1-401-P	20-1, 20-10	400	1	119,50
-702921	2-151-P	20-2, 20-20	150	1	107,50
-703188	2-301-P	20-2, 20-20	300	1	134,80
-726521	3-201-P	20-3, 20-30, 20-4, 20-40	200	1	175,50
-726781	3-301-P	20-3, 20-30, 20-4, 20-40	300	1	210,70
-726941	3-401-P	20-3, 20-30, 20-4, 20-40	400	1	247,20
-727108	3-501-P	20-3, 20-30, 20-4, 20-40	500	1	262,80



### 20 2-armige Abzieher für Getriebezahnräder

2-arm pullers  
Extracteurs à 2 bras  
Extractores de 2 brazos  
2-armige trekkers

für / for / pour / para  
VW Audi 2007

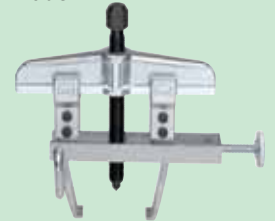

ST	EAN-Code 4021176-	Art.-No.				Euro
	-907944	20-10-V	120	100	1	223,6





**20+** 2-armige Abzieher  
 2-arm pullers  
 Extracteur à 2 bras  
 Extractores de 2 brazos  
 2-armige trekkers

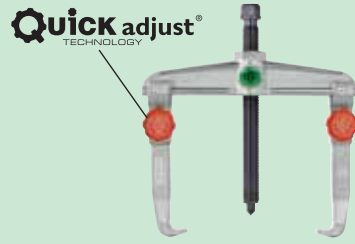

10	EAN-Code	Art.-No.	mm	mm		Euro
ST	4021176-644771	20-1+	90	100	1	82,30
	4021176-644856	20-10+	120	100	1	88,20
	4021176-644931	20-2+	160	150	1	155,10
	4021176-645013	20-20+	200	150	1	167,60
	4021176-645198	20-3+	250	200	1	282,00
	4021176-645273	20-30+	350	200	1	304,80

**20-ST+** Verkaufs- und Werkstattständer  
 Sales display and workshop stand  
 Stand de vente et d'atelier  
 Caballete de exhibición y de talleres  
 Verkoop- en werkplaatsstandaard

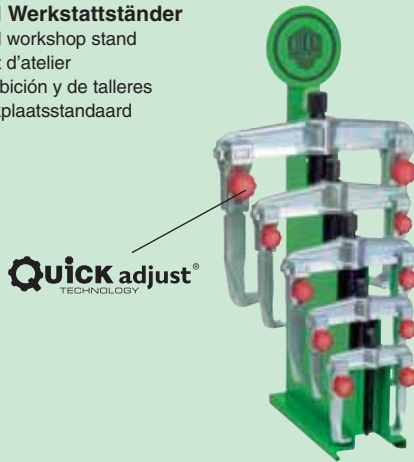

10	EAN-Code	Art.-No.	Inhalt		Euro
ST	4021176-668944	20-ST+	20-1+, 20-10+, 20-2+, 20-20+, 20-3+	1	770,80

**20+B** 2-armige Abzieher  
 2-arm pullers  
 Extracteur à 2 bras  
 Extractores de 2 brazos  
 2-armige trekkers

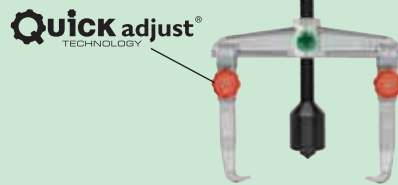

7 + 10 to  
**hydraulic**  
 TECHNOLOGY

ST	EAN-Code	Art.-No.	mm	mm	to/KN	mit		Euro
ST	4021176-885815	20-2+B	160	150	7/ 70	8-01	1	393,90
	4021176-885846	20-20+B	200	150	7/ 70	8-01	1	409,40
	4021176-885891	20-3+B	250	200	10/100	8-02	1	494,30
	4021176-885945	20-30+B	350	200	10/100	8-02	1	508,30

**20+S** 2-armige Abzieher  
 2-arm pullers  
 Extracteur à 2 bras  
 Extractores de 2 brazos  
 2-armige trekkers

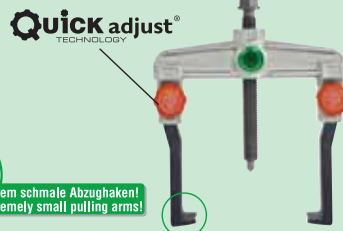

für enge Zwischenräume  
 for confined spaces  
 pour endroits exigues  
 para intersticios angostos  
 voor nauwe tussenruimtes



10	EAN-Code	Art.-No.	mm	mm		Euro
ST	4021176-756221	20-1+S	90	100	1	99,50
	4021176-756306	20-10+S	120	100	1	104,70
	4021176-756481	20-2+S	160	150	1	186,60
	4021176-756559	20-20+S	200	150	1	198,60
	4021176-756634	20-3+S	250	200	1	331,20
	4021176-756719	20-30+S	350	200	1	354,20

**20-Q** 2-armige Abzieher  
 2-arm pullers  
 Extracteurs à 2 bras  
 Extractores de 2 brazos  
 2-armige trekkers

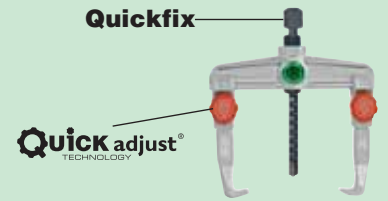

12	EAN-Code	Art.-No.	mm	mm		Euro
ST	4021176-752346	20-10-Q	120	100	1	225,00
	4021176-752421	20-20-Q	200	150	1	340,80
	4021176-752599	20-3-Q	250	200	1	496,60

**20-QS** 2-armige Abzieher  
 2-arm pullers  
 Extracteurs à 2 bras  
 Extractores de 2 brazos  
 2-armige trekkers

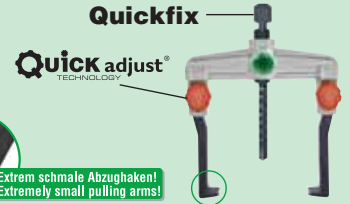

für enge Zwischenräume  
 for confined spaces  
 pour endroits exigues  
 para intersticios angostos  
 voor nauwe tussenruimtes



12	EAN-Code	Art.-No.	mm	mm		Euro
ST	4021176-752674	20-10QS	120	100	1	243,10
	4021176-752759	20-20QS	200	150	1	372,20
	4021176-752834	20-3QS	250	200	1	545,90

**xxx2-P** 2 Abzughaken  
 2 Pulling arms  
 2 Griffes d'extraction  
 2 Garras de extracción  
 2 Trekhaken



ST	EAN-Code	Art.-No.	für	mm		Euro
ST	4021176-732393	1-92-P	20-1+, 20-10+	100	1	43,80
	4021176-973611	1-192-P	20-1+, 20-10+	200	1	62,70
	4021176-973673	1-252-P	20-1+, 20-10+	250	1	78,00
	4021176-973765	2-152-P	20-2+, 20-20+	150	1	78,40
	4021176-973819	2-302-P	20-2+, 20-20+	300	1	108,30
	4021176-732706	3-202-P	20-3+, 20-30+	200	1	136,30
	4021176-973932	3-302-P	20-3+, 20-30+	300	1	169,40
	4021176-974014	3-402-P	20-3+, 20-30+	400	1	203,80
	4021176-974137	3-502-P	20-3+, 20-30+	500	1	227,40

**x-V-xxx-P** 2 Verlängerungen  
 2 Extensions  
 2 Rallonges  
 2 Alargaderas  
 2 Verlengstukken



ST	EAN-Code	Art.-No.	für	L		Euro
ST	4021176-985058	1-V-100-P	20-1, 20-10	100	1	27,00
	4021176-985089	1-V-150-P	20-1, 20-10	150	1	35,90
	4021176-985201	2-V-150-P	20-2, 20-20	150	1	62,70

**xxx3-P** 2 Abzughaken  
 2 Pulling arms  
 2 Griffes d'extraction  
 2 Garras de extracción  
 2 Trekhaken



ST	EAN-Code	Art.-No.	für	mm		Euro
ST	4021176-973352	1-93-P	20-1+S, 20-10+S	100	1	61,10
	4021176-973642	1-193-P	20-1+S, 20-10+S	200	1	73,40
	4021176-973710	1-253-P	20-1+S, 20-10+S	250	1	91,90
	4021176-973789	2-153-P	20-2+S, 20-20+S	150	1	109,10
	4021176-973857	2-303-P	20-2+S, 20-20+S	300	1	136,80
	4021176-973901	3-203-P	20-3+S, 20-30+S	200	1	179,10
	4021176-973970	3-303-P	20-3+S, 20-30+S	300	1	213,80
	4021176-974052	3-403-P	20-3+S, 20-30+S	400	1	250,80
	4021176-974175	3-503-P	20-3+S, 20-30+S	500	1	266,40



# INFO-BOX: 3 Gleithämmer für alle Anwendungen

## Innenauszieher mit im Gesenk geschmiedeten Schalen, Baureihe 21

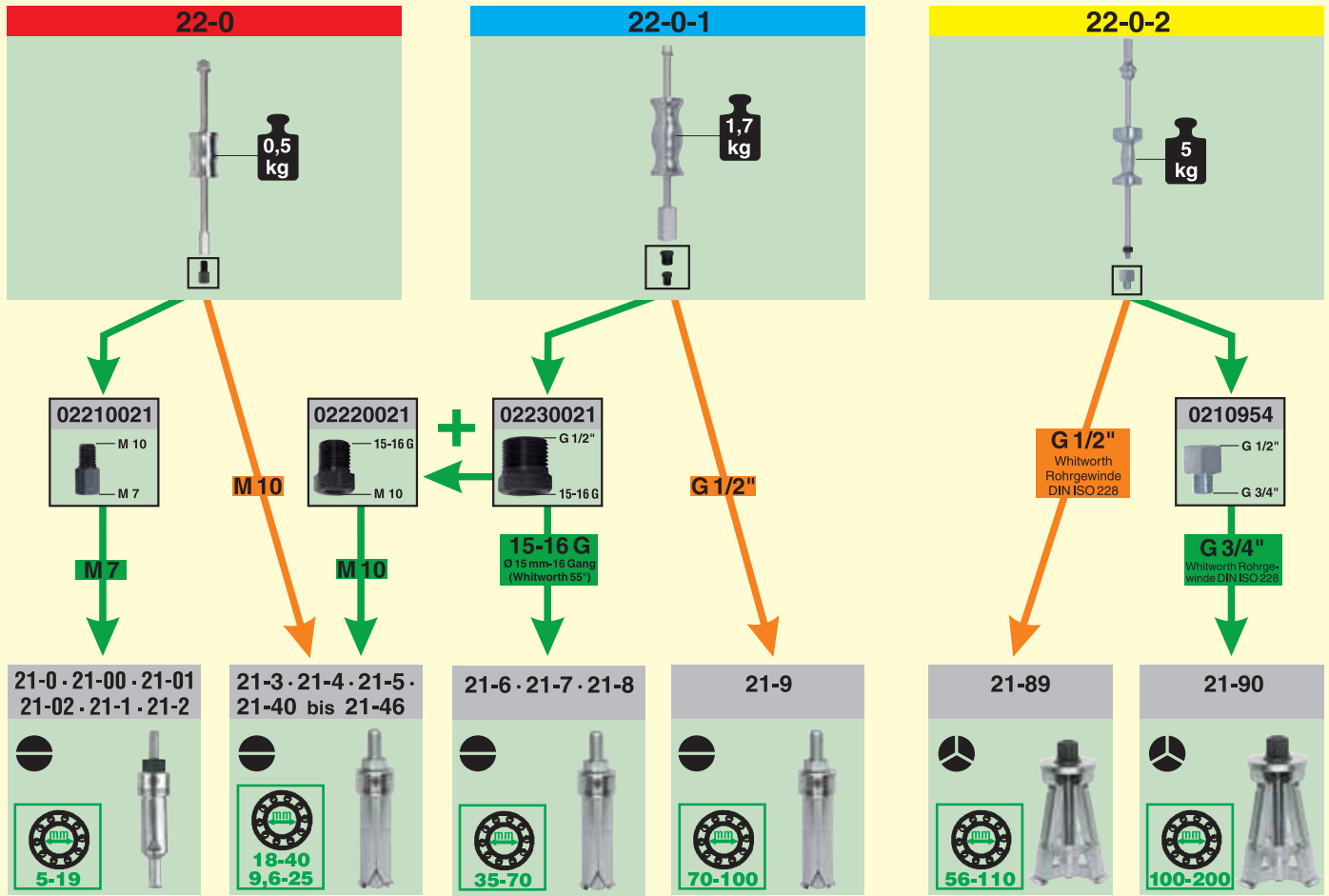

## Innenauszieher mit segmentierten Greifflächen, Baureihe 21-x-E

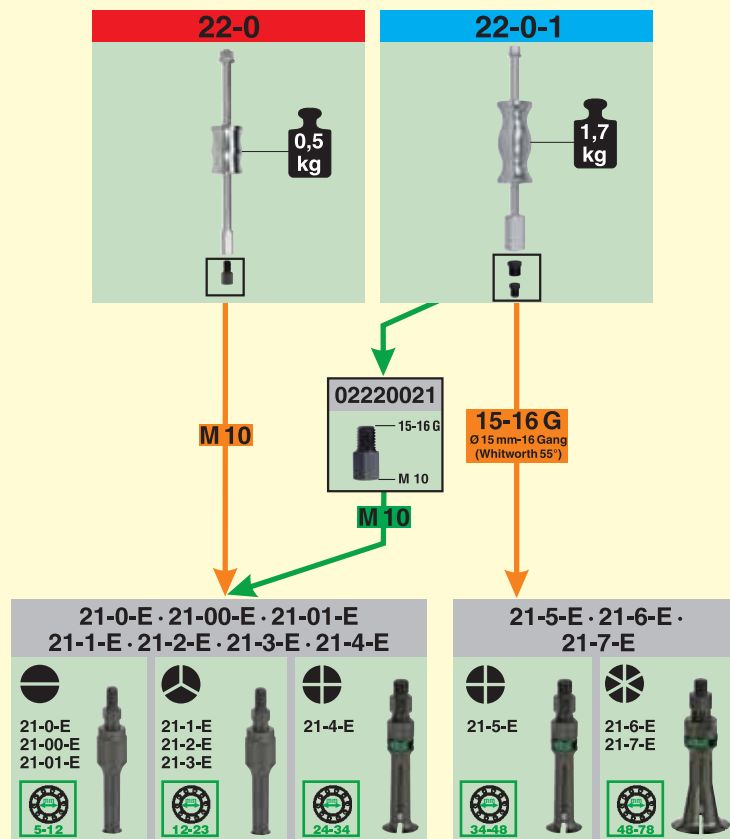

22-0-x

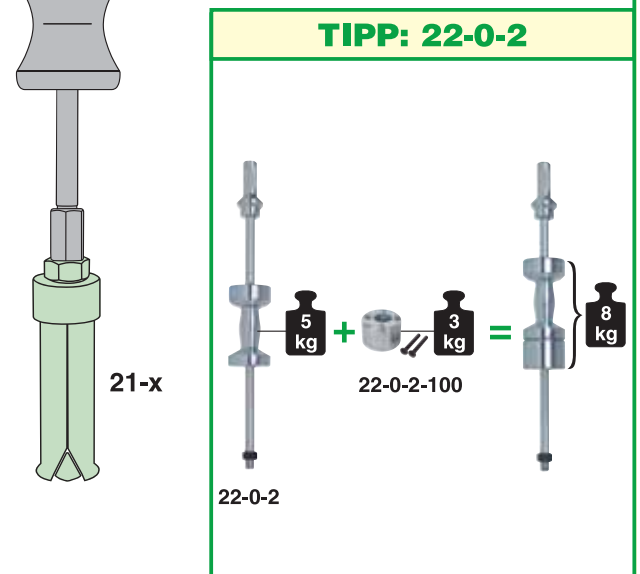



**21 Innenauszieher**  
Internal extractors  
Extracteurs intérieurs  
Extractores interiores  
Binnentrekkers

40	EAN-Code	Art.-No.	mm	passend zu suitable for/s'adaptant à	L mm	Euro
ST	4021176-					
	-010408	21-0	5- 8	22-1, 22-0	73	46,40
	-010576	21-00	6-10	22-1, 22-0	73	46,40
	-010651	21-01	8-12	22-1, 22-0	73	46,40
	-010736	21-02	10-14	22-1, 22-0	73	46,40
	-010811	21-1	12-16	22-1, 22-0	72	37,90
	-010996	21-2	14-19	22-1, 22-0	72	38,00
	-011153	21-3	18-23	22-1, 22-2, 22-0-1, 22-0	89	49,50
	-011238	21-4	20-30	22-1, 22-2, 22-0-1, 22-0	92	52,80
	-011498	21-5	28-40	22-1, 22-2, 22-0-1, 22-0	101	61,80
	-011566	21-6	35-46	22-2, 22-3, 22-0-1	113	73,10
	-011641	21-7	45-58	22-2, 22-3, 22-0-1	135	100,40
	-011726	21-8	56-70	22-2, 22-3, 22-0-1	133	123,60
	-011986	21-9	70-100	22-3, 22-0-1	166	193,20
	-011801	21-89	56-110	22-4, 22-0-2	185	279,60
	-012068	21-90	100-200	22-5, 22-0-2	220	369,40

**21-E Innenauszieher** Ausführung mit Segmentspannung  
Internal extractors Segment grip type  
Extracteurs intérieurs Type avec mors en forme de segment  
Extractores interiores Tipo con uñas segmentadas  
Binnentrekkers Uitvoering met segmentspanning

ST	EAN-Code	Art.-No.	mm	passend zu suitable for/s'adaptant à	L mm	Euro
	4021176-					
	-909153	21-0-E	4,8- 6,5	22-0, 22-0-1, 22-1, 22-2	54	46,40
	-909160	21-00-E	6,8- 9,5	22-0, 22-0-1, 22-1, 22-2	54	46,40
	-909177	21-01-E	9,5-12,5	22-0, 22-0-1, 22-1, 22-2	54	46,40
	-930003	21-1-E	12,0-16,0	22-0, 22-0-1, 22-1, 22-2	80	38,00
	-931000	21-2-E	14,0-19,0	22-0, 22-0-1, 22-1, 22-2	83	38,00
	-931109	21-3-E	18,0-23,0	22-0, 22-0-1, 22-1, 22-2	90	50,00
	-909184	21-4-E	24,0-34,0	22-0, 22-0-1, 22-1, 22-2	98	53,00
	-924071	21-5-E	34,0-48,0	22-2, 22-0-1	110	63,00
	-924088	21-6-E	48,0-63,0	22-2, 22-0-1	120	73,00
	-924095	21-7-E	63,0-78,0	22-2, 22-0-1	120	98,00

**21-V-0 Verlängerungen für Innenauszieher**  
Extensions for internal extractors  
Ralonges pour extracteurs intérieurs  
Alargaderas para extractores interiores  
Binnentrekker verlengstukken

passend zu / suitable for / s'adaptant à / geschikt voor  
21-V-040 21-0, 21-00, 21-01, 21-02  
21-V-060 und/and/et/y  
21-V-080 21-1, 21-2 (siehe oben)  
21-V-310 21-4, 21-5 und/and/et/y  
21-3 (siehe oben)

ST	EAN-Code	Art.-No.		Euro
	4021176-			
	-909207	21-V-0	Satz / Set / Jeu	100,00
	-909214	21-V-040	↔ 40 mm	25,20
	-909221	21-V-060	↔ 60 mm	29,40
	-909238	21-V-080	↔ 80 mm	33,50
	-914386	21-V-310	↔ 100 mm	40,70

**21-40 – 21-46 Nadellager Auszieher**  
Needle bearing extractors  
Extracteurs roulements à aiguilles  
Extractores de cojinetes de agujas  
Naaldlager binnentrekkers

43	EAN-Code	Art.-No.	mm	passend zu suitable for/s'adaptant à	L mm	Euro
ST	4021176-					
	-411526	21-40	9,6-18	22-1, 22-2, 22-0-1, 22-0	92	77,50
	-186066	21-41	11,5-19	22-1, 22-2, 22-0-1, 22-0	92	77,50
	-186141	21-42	12,5-21	22-1, 22-2, 22-0-1, 22-0	92	77,50
	-186226	21-43	14,5-22	22-1, 22-2, 22-0-1, 22-0	92	77,50
	-186301	21-44	16,5-23	22-1, 22-2, 22-0-1, 22-0	92	77,50
	-186486	21-45	18,5-24	22-1, 22-2, 22-0-1, 22-0	92	77,50
	-186554	21-46	20 -25	22-1, 22-2, 22-0-1, 22-0	92	77,50

**21-89/21-90 Innenauszieher**  
Internal extractors  
Extracteurs intérieurs  
Extractores interiores  
Binnentrekkers

41	EAN-Code	Art.-No.	mm	passend zu suitable for/s'adaptant à	L mm	Euro
ST	4021176-					
	-011801	21-89	56-110	22-4, 22-0-2	185	279,60
	-012068	21-90	100-200	22-5, 22-0-2	220	369,40

**22 Gleithammer-Vorrichtungen**  
Slide hammer devices  
Dispositifs à masse coulissante  
Martillos de correa  
Glijhamer- gereedschap

NEU - NEW

ST	EAN-Code	Art.-No.	passend zu suitable for/s'adaptant à/geschikt voor	kg	Euro
	4021176-				
	-012143	22-0	21-0 - 21-2; 21-0-E - 21-4-E	0,70	38,70
	-555558	22-0-1	21-3 - 21-9; 21-40 - 21-46; 21-0-E - 21-7-E	2,50	93,20
	-111204	22-0-2	21-89; 21-90	6,50	160,00
	-111211	22-0-2-100	22-0-2	3,00	40,00

**Info**

Die Schlagkraft des Gleithammers kann durch das Einschrauben von Zusatzgewichten optional erhöht werden.

**KS-22 Gleithammersatz**  
Set of slide hammer  
Jeu de dispositifs à masse coulissante  
Juegos de martillos de correa  
Glijhamer- gereedschap-sets

KS-22-01 Gewindestift austauschbar!

KS-22-02 für die Landwirtschaft + LKW  
for the agriculture + LKW  
pour la agriculture + LKW

10-teilig/parts

ST	EAN-Code	Art.-No.	Inhalt: contents/contenu/inhoud	Euro
	4021176-			
	-924569	KS-22-01	Adapter: M3; M4; M5; M6; M8; M10; verzinkt/zinc-plated: M7; M10; 15-16G; 22-01-GH = M12	117,00
	-951121	KS-22-02	Adapter: M6; M8x1; M10; M10x1; M12x1; M15x1,5 verzinkt/zinc-plated: M7; M10; 15-16G; 22-01-GH = M12	117,00

**Universal-Gleithammer-Sätze KS-22-01 und KS-22-02**

können mit allen handelsüblichen Innenausziehern verwendet werden. Passend zu KUKKO-Innenausziehern: 21-0 – 21-8 und 21-0-E – 21-7-E. Ebenfalls können die Gleithammer-Vorrichtungen überall dort eingesetzt werden, wo Gewindestifte direkt ins abzuziehende Teil eingeschraubt werden können.





# INFO-BOX: Gegenstützen

## Innenauszieher mit im Gesenk geschmiedeten Schalen, Baureihe 21

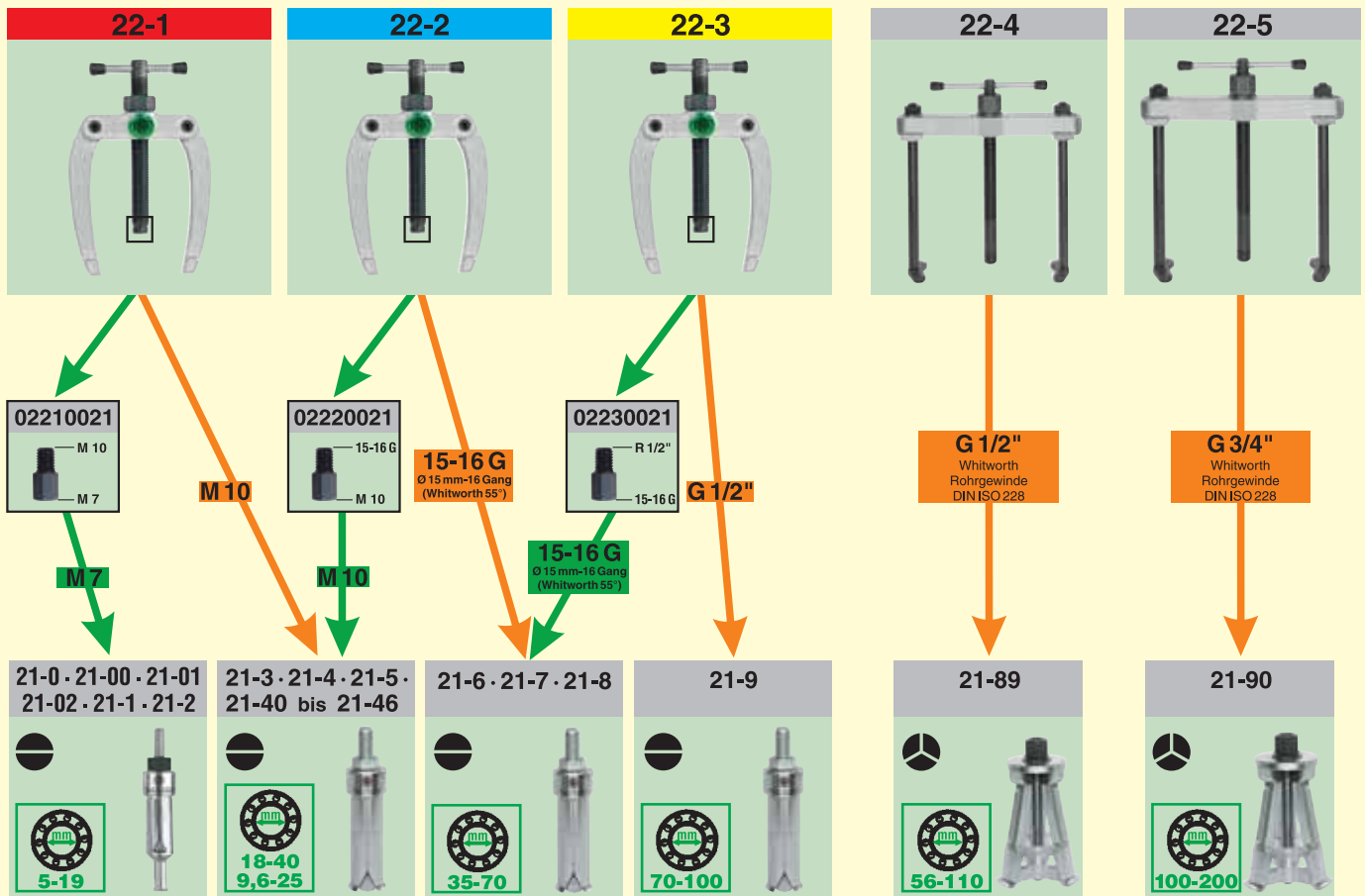

## Innenauszieher mit segmentierten Greifflächen, Baureihe 21-x-E

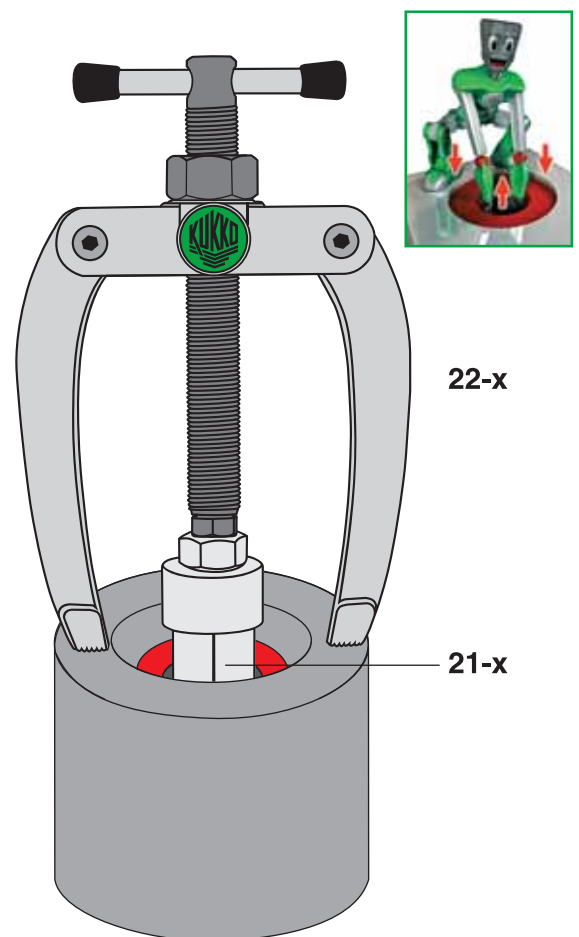
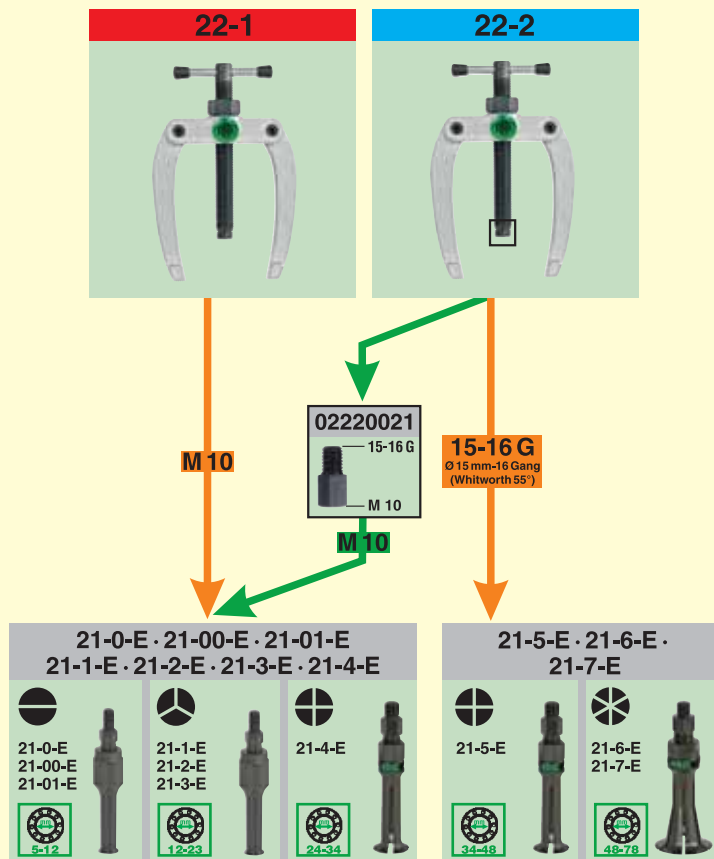



## 22 Gegenstützen

Counterstays  
Contre-appuis  
Contraapoyos  
Tegensteunen

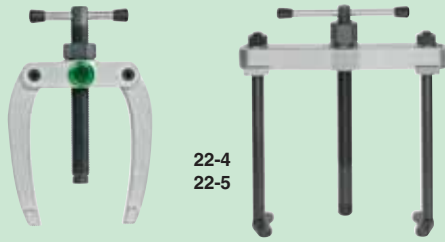

40	EAN-Code	Art.-No.	passend zu		Euro
ST	4021176-		suitable for/s'adaptant à/geschikt voor		
	-012228	22-1	21-0 - 21-5; 21-0-E - 21-4-E	1	52,70
	-012303	22-2	21-3 - 21-8; 21-0-E - 21-7-E	1	71,00
	-012488	22-3	21-6 - 21-9	1	147,00
41	-112478	22-4	21-89	1	166,20
	-012556	22-5	21-90	1	216,30

## 22-1-AS Gewindeadapter

Screw adapters  
Adaptateurs  
Adaptadores  
Schroefdraadadapters



44	EAN-Code	Art.-No.	passend zu		Euro
ST	4021176-		suitable for/s'adaptant à/geschikt voor		
	-339288	22-1-AS	22-1; 22-2; 22-3	1	47,90

## 23 Abziehfutter

Pulling chuck  
Mandrin d'extraction  
Mandril extractor  
Klauwkoptrekker

für Rillenkugellager Innenringe  
for deep groove bearing inner races  
pour bagues intérieures de roulement  
para anillos interiores de cojinetes  
voor kogellager-binnenringen



42	EAN-Code	Art.-No.	b		Euro
ST	4021176-		mm		
	-012631	23	5-32	1	193,20

## 24 Kugellager-Ab- und Auszieh-Sätze

Sets of bearing pulling and extracting tools  
Jeu de arracheurs de roulement ext. et int.  
Juegos de extractores de cojinetes ext. y int.  
Kogellager buiten- en binnentrekker-sets



24-A 11-teilig/parts  
24-B 14-teilig/parts  
24-C 15-teilig/parts

41	EAN-Code	Art.-No.	Inhalt		Euro
ST	4021176-		contents/contenu/inhoud		
	-012716	24-A	21-1 - 21-6, 22-1+22-2, 23, 43-1, 20-1	1	780,20
	-012891	24-B	21-1 - 21-8, 22-1+22-2, 23, 43-1, 20-1+20-2	1	1158,70
	-012976	24-C	21-1 - 21-7, 21-89, 22-1, 22-2, 22-4, 23, 43-1, 20-1+20-2	1	1508,00

## 25 Kugellager-Auszieh-Sätze

Sets of bearing extracting tools  
Jeu de arracheurs de roulements intérieurs  
Juegos de extractores interiores de cojinetes  
Kogellager binnentrekker-sets



25-K 4-teilig/parts  
25-A 8-teilig/parts  
25-B 10-teilig/parts  
25-C 11-teilig/parts  
25-N 7-teilig/parts

43	EAN-Code	Art.-No.	Inhalt	mm		Euro
ST	4021176-		contents/contenu/inhoud			
	-863899	25-K	21-00 / 21-02 / 21-2 / 22-1	6- 19	1	245,60
	-013058	25-A	21-1 - 21-6 / 22-1 / 22-2	12- 46	1	469,20
41	-013133	25-B	21-1 - 21-8 / 22-1 / 22-2	12- 70	1	718,60
	-013218	25-C	21-1 - 21-7/21-89/22-1/22-2/22-4	12-110	1	1069,80
ST	-787096	25-N	21-41 - 21-46 / 22-1	9,6- 25	1	595,00

## 26 Kugellager-Schlagauszieher-Sätze

Percussion type bearing extractor sets  
Jeu d'arracheurs de roulements int. à masse coulissante  
Juegos de extractores int. de cojinetes con martillo de correa  
Kogellager binnentrekkers met slagtrekker-sets

26-A 4-teilig/parts Ø 6-16 mm  
26-B 8-teilig/parts Ø 6-40 mm  
26-C 8-teilig/parts Ø 8-46 mm  
26-D 4-teilig/parts Ø 25-58 mm



42	EAN-Code	Art.-No.	Inhalt		Euro
ST	4021176-		contents/contenu/inhoud		
	-781629	26-A	21-00/21-02/21-1/22-0	1	183,90
	-781704	26-B	21-00/21-01/21-1/21-2/21-4/21-5/22-0/22-0-1	1	467,50
	-781889	26-C	21-01/21-1/21-2/21-4/21-5/21-6/22-0/22-0-1	1	540,80
	-781964	26-D	21-5/21-6/21-7/22-0-1	1	392,30



## Tanos® Systainer NEU bei KUKKO

Der Tanos-KUKKO-Koffer ist mit allen Tanos-Systemkoffern kombinierbar, so dass alle Werkzeuge sicher aufbewahrt und transportiert werden können.



## 27-A Universalabziehersatz im TANOS-Systainer®

Universal puller set in TANOS-Systainer®  
Jeu d'extracteurs universels en TANOS-Systainer®  
Juego de extractores en TANOS-Systainer®  
Universeel trekker-set in TANOS-Systainer®

21-teilig/parts

für kleine Lager mit Ø 8-48 mm  
for small bearings with Ø 8-48 mm  
pour palier petit avec Ø 8-48 mm



41	EAN-Code	Art.-No.	Inhalt		Euro
ST	4021176-		contents/contenu/inhoud		
	951008	27-A	21-01-E - 21-5-E; 69-A1 - 69-A3; 22-01-G27-A; 43-001; 204-0	1	826,00



### 28 Schnellspannabzieher

Quick adjusting pullers  
Extracteurs à serrage rapide  
Extractores con regulación rápida  
Snelspan trekkers

*selbstverriegelnd  
self locking  
autobloquantes  
autoenclavandos  
zelfvergrendelend*



22	EAN-Code	Art.-No.	mm	mm		Euro
ST	4021176-					
	-850929	28-1	125	100	1	128,60
	-851001	28-2	150	125	1	137,20
	-851186	28-3	200	175	1	152,30
	-851261	28-4	250	200	1	161,10

### 29-B Universalabziehersatz im TANOS-Systainer®

Universal puller set in TANOS-Systainer®  
Jeu d'extracteurs universels en TANOS-Systainer®  
Juego de extractores en TANOS-Systainer®  
Universeel trekker-set in TANOS-Systainer®

**NEU-NEW**



für Lager  
for bearing  
Ø 8-48 mm

ST	EAN-Code	Art.-No.	Inhalt contents/contenu/inhoud		Euro
	4021176-				
	111129	29-B	15-2; 18-2; 19-2-P; 69-1; 70-1; 70-711 70-712; 70-713; 204-02; 482-3; 483-3	1	1720,00

### 30 3-armige Abzieher

3-arm pullers  
Extracteurs à 3 bras  
Extractores de 3 brazos  
3-armige trekkers



14	EAN-Code	Art.-No.	mm	mm		Euro
ST	4021176-					
	-013393	30-1	90	100	1	104,60
	-013621	30-10	130	100	1	112,70
	-013478	30-2	160	150	1	199,40
	-013706	30-20	200	150	1	218,60
	-013546	30-3	250	200	1	377,10
	-901256	30-3-25	250	250	1	450,80

### 30 3-armige Abzieher

3-arm pullers  
Extracteurs à 3 bras  
Extractores de 3 brazos  
3-armige trekkers

*mit längeren Abzughaken  
with extended pulling arms  
avec griffes plus longues  
con garras más largos  
met verlengde trekhaken*



14	EAN-Code	Art.-No.	mm	mm		Euro
ST	4021176-					
	-730726	30-1-2	90	200	1	129,50
	-730801	30-10-2	130	200	1	137,50
	-730986	30-2-3	160	300	1	243,40
	-731068	30-20-3	200	300	1	263,00
	-901256	30-3-25	250	250	1	450,80
	-731143	30-3-3	250	300	1	436,40
	-731228	30-3-4	250	400	1	487,60
	-731303	30-3-5	250	500	1	500,70

### 30 B 3-armige Abzieher

3-arm pullers  
Extracteurs à 3 bras  
Extractores de 3 brazos  
3-armige trekkers



7 + 10 to  
**hydraulic**  
TECHNOLOGY

ST	EAN-Code	Art.-No.	mm	mm	to/KN	mit with/avec		Euro
	4021176-							
	-886317	30-2-B	160	150	7/ 70	8-01	1	393,00
	-886348	30-20-B	200	150	7/ 70	8-01	1	412,20
	-886393	30-3-B	250	200	10/100	8-02	1	580,40

### 30 B 3-armige Abzieher

3-arm pullers  
Extracteurs à 3 bras  
Extractores de 3 brazos  
3-armige trekkers

*mit längeren Abzughaken  
with extended pulling arms  
avec griffes plus longues  
con garras más largos  
met langere trekhaken*



7 + 10 to  
**hydraulic**  
TECHNOLOGY

ST	EAN-Code	Art.-No.	mm	mm	to/KN	mit with/avec		Euro
	4021176-							
	-886300	30-2-3-B	160	300	7/ 70	8-01	1	437,10
	-886331	30-20-3-B	200	300	7/ 70	8-01	1	456,30
	-886362	30-3-3-B	250	300	10/100	8-02	1	639,90
	-886379	30-3-4-B	250	400	10/100	8-02	1	690,80
	-886386	30-3-5-B	250	500	10/100	8-02	1	704,20

### 30-P3 3-armiger Abzieher

3-arm puller  
Extracteur à 3 bras  
Extractor de 3 brazos  
3-armige trekkers

**NEU-NEW**



ST	EAN-Code	Art.-No.	mm	mm		Euro
	4021176-					
	111136	30-10-P3	130	100-350	1	300,00
	111150	30-20-P2	200	150/300	1	320,00
	111174	30-3-P3	350	200/300/400	1	790,00

### K-2030-10 2- und 3-armiger Universalabzieher-Satz

Set of two- and three-arm pullers  
Jeu d'extracteurs universels à 2- et 3 bras  
Juego de extractores universales de 2 y 3 brazos  
2- en 3-armige universele trekkers-set

Inhalt / contents:  
20-10-P3 30-10-P3 614250



ST	EAN-Code	Art.-No.	mm	mm		Euro
	4021176-					
	-974748	K-2030-10	120	100-350	1	324,40



### 30-20-T Universal Abzieher Satz auf Lochtafel

Universal puller set on wall panel  
 Jeu d'extracteurs universels sur panneau  
 Juego de extractores universales en panel mural  
 Universeel trekker-set op wandbord



*Satz/Set/Jeu*  
 14-teilig/parts  
 20-10, 20-10-2,  
 30-10, 30-10-2,  
 20-20, 20-20-3,  
 30-20, 30-20-3,  
 15-2, 699999

13 ST	EAN-Code	Art.-No.	mm	mm	mm		Euro
	4021176-875717	30-20-T	0-200	100-300	22-115	1	795,50

### 30-S 3-armige Abzieher

3-arm pullers  
 Extracteurs à 3 bras  
 Extractores de 3 brazos  
 3-armige trekkers



für enge Zwischenräume  
 for confined spaces  
 pour endroits exigues  
 para intersticios angostos  
 voor nauwe tussenruimtes



Extrem schmale Abzughaken!  
 Extremely small pulling arms!

15 ST	EAN-Code	Art.-No.	mm	mm		Euro
	4021176-727771	30-1-S	90	100	1	132,40
	-728198	30-10-S	130	100	1	140,70
	-727856	30-2-S	160	150	1	246,30
	-727931	30-20-S	200	150	1	265,20
	-728013	30-3-S	250	200	1	450,80
	-871221	02000025	@ für/for/pour -1 + -10		1	PG 1
	-871238	02002125	@ für/for/pour -2 + -20		1	PG 2
	-871245	02003225	@ für/for/pour -3		1	PG 3

### WT-50 Universal-Abzieher-Satz auf Lochtafel

Universal puller set on wall panel  
 Jeu d'extracteurs universels sur panneau  
 Juego de extractores universales en panel mural  
 Universeel trekker-set op wandbord



*Satz/Set/Jeu*  
 16-teilig/parts  
 20-10+, 20-10-2+,  
 30-10+, 30-10-2+,  
 20-20+, 20-20-3+,  
 30-20+, 30-20-3+,  
 15-2+, 9-1, 18-2,  
 699999

15 ST	EAN-Code	Art.-No.	mm	mm	mm		Euro
	4021176-951114	WT-50	0-200	100-300	22-115	1	855,00

### 30-SP 3-armiger Abzieher

3-arm puller  
 Extracteur à 3 bras  
 Extractor de 3 brazos  
 3-armige trekkers



für enge Zwischenräume  
 for confined spaces  
 pour endroits exigues  
 para intersticios angostos  
 voor nauwe tussenruimtes



Extrem schmale Abzughaken!  
 Extremely small pulling arms!

15 ST	EAN-Code	Art.-No.	mm	mm		Euro
	4021176-463839	30-10-SP	130	100-350	1	378,40
	-728273	30-20-SP	200	150/300	1	466,80
	-728358	30-3-SP	250	200/300/400	1	1132,80

### x-xx0-S 3 Abzughaken

3 Pulling arms  
 3 Griffes d'extraction  
 3 Garras de extracción  
 3 Verlengde trekhaken



14 ST	EAN-Code	Art.-No.	für for/pour	mm		Euro
	4021176-001413	1-90-S	No. 30-1, 30-10	100	1	62,20
	-002571	2-150-S	No. 30-2, 30-20	150	1	115,80
	-003318	3-200-S	No. 30-3, 11	200	1	194,70
	-001741	1-190-S	30-1, 30-10	200	1	92,70
	-002083	1-250-S	30-1, 30-10	250	1	111,20
	-975684	1-400-S	30-1, 30-10	400	1	168,00
	-002816	2-300-S	30-2, 30-20	300	1	162,30
	-003646	3-300-S	30-3, 11	300	1	250,20
	-003981	3-400-S	30-3, 11	400	1	301,40
	-004223	3-500-S	30-3, 11	500	1	315,10

### K-2030-10-S 2- und 3-armiger Universalabzieher-Satz

Set of two- and three-arm pullers  
 Jeu d'extracteurs universels à 2- et 3 bras  
 Juego de extractores universales de 2 y 3 brazos  
 2- en 3-armige universele trekkers-set

Inhalt / contents:  
 20-10-SP 30-10-SP 614250



für enge Zwischenräume  
 for confined spaces  
 pour interstices étroits  
 para intersticios angostos  
 voor nauwe tussenruimtes



Extrem schmale Abzughaken!  
 Extremely small pulling arms!

11 ST	EAN-Code	Art.-No.	mm	mm		Euro
	4021176-306181	K-2030-10-S	120	100-350	1	477,40

### x-V-xxx-S 3 Verlängerungen

3 Extensions  
 3 Rallonges  
 3 Alargaderas  
 3 Verlengstukken

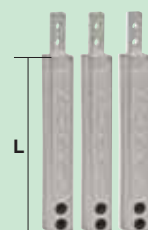

15 ST	EAN-Code	Art.-No.	für for/pour	L mm		Euro
	4021176-985065	1-V-100-S	30-1, 30-10	100	1	40,30
	-985096	1-V-150-S	30-1, 30-10	150	1	53,80
	-985218	2-V-150-S	30-2, 30-20	150	1	94,20



Die beiden KUKKO-Herpa-LKW-Modelle haben zusammen bis jetzt eine Entfernung von über 7.000 km zurückgelegt.  
 Sie fahren im Miniatur-Wunderland im Bauabschnitt Knuffingen, unter den Nummern 77 und 164.





**xxx1-S 3 Abzughaken** für enge Zwischenräume  
 3 Pulling arms for confined spaces  
 3 Griffes d'extraction pour endroits exigues  
 3 Garras de extracción para intersticios angostos  
 3 Trekhaken voor nauwe tussenruimtes



15	EAN-Code	Art.-No.	für for / pour	mm		Euro
ST	4021176-					
	-497834	1-91-S	30-1, 30-10	100	1	116,20
	-497919	1-191-S	30-1, 30-10	200	1	108,60
	-498091	1-251-S	30-1, 30-10	250	1	131,20
	-985034	1-401-S	30-1, 30-10	400	1	179,10
	-728686	2-151-S	30-2, 30-20	150	1	161,40
	-728761	2-301-S	30-2, 30-20	300	1	202,20
	-728846	3-201-S	30-3	200	1	263,40
	-728921	3-301-S	30-3	300	1	316,20
	-729003	3-401-S	30-3	400	1	371,00
	-729188	3-501-S	30-3	500	1	393,90

**30 plus 3-armige Abzieher**  
 3-arm pullers  
 Extracteurs à 3 bras  
 Extractores de 3 brazos  
 3-armige trekkers



15	EAN-Code	Art.-No.	mm	mm		Euro
ST	4021176-					
	-731488	30-1+	90	100	1	106,00
	-731556	30-10+	130	100	1	123,80
	-731631	30-2+	160	150	1	222,30
	-731716	30-20+	200	150	1	241,20
	-731891	30-3+	250	200	1	413,20

**30+B 3-armige Abzieher**  
 3-arm pullers  
 Extracteurs à 3 bras  
 Extractores de 3 brazos  
 3-armige trekkers



7 + 10 to  
**hydraulic**  
 TECHNOLOGY

ST	EAN-Code	Art.-No.	mm	mm	to/KN	mit with/avec		Euro
	4021176-							
	-886294	30-2+B	160	150	7/ 70	8-01	1	415,80
	-886324	30-20+B	200	150	7/ 70	8-01	1	434,80
	-886355	30-3+B	250	200	10/100	8-02	1	616,70

**xxx2-S 3 Abzughaken**  
 3 Pulling arms  
 3 Griffes d'extraction  
 3 Garras de extracción  
 3 Trekhaken



ST	EAN-Code	Art.-No.	für for/pour	mm		Euro
	4021176-					
	-973741	1-92-S	30-1+, 30-10+	100	1	65,40
	-973635	1-192-S	30-1+, 30-10+	200	1	94,20
	-973697	1-252-S	30-1+, 30-10+	250	1	117,00
	-973772	2-152-S	30-2+, 30-20+	150	1	117,60
	-973833	2-302-S	30-2+, 30-20+	300	1	176,60
	-973895	3-202-S	30-3+, 30-30+	200	1	204,30
	-973956	3-302-S	30-3+, 30-30+	300	1	253,90
	-974038	3-402-S	30-3+, 30-30+	400	1	305,60
	-974151	3-502-S	20-3+, 20-30+	500	1	341,10

**30+S 3-armige Abzieher**  
 3-arm pullers  
 Extracteurs à 3 bras  
 Extractores de 3 brazos  
 3-armige trekkers

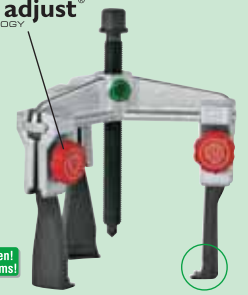

für enge Zwischenräume  
 for confined spaces  
 pour endroits exigues  
 para intersticios angostos  
 voor nauwe tussenruimtes



15	EAN-Code	Art.-No.	mm	mm		Euro
ST	4021176-					
	-756894	30-1+S	90	100	1	132,30
	-756979	30-10+S	130	100	1	149,90
	-757051	30-2+S	160	150	1	269,10
	-757136	30-20+S	200	150	1	288,30
	-757211	30-3+S	250	200	1	487,10

**xxx3-S 3 Abzughaken**  
 3 Pulling arms  
 3 Griffes d'extraction  
 3 Garras de extracción  
 3 Trekhaken



Extrem schmale Abzughaken!  
 Extremely small pulling arms!



ST	EAN-Code	Art.-No.	für for/pour	mm		Euro
	4021176-					
	-973758	1-93-S	30-1+S, 30-10+S	100	1	91,50
	-973659	1-193-S	30-1+S, 30-10+S	200	1	110,00
	-973734	1-253-S	30-1+S, 30-10+S	250	1	137,60
	-973796	2-153-S	30-2+S, 30-20+S	150	1	163,90
	-973871	2-303-S	30-2+S, 30-20+S	300	1	205,10
	-973918	3-203-S	30-3+S, 30-30+S	200	1	268,70
	-973994	3-303-S	30-3+S, 30-30+S	300	1	320,60
	-974076	3-403-S	30-3+S, 30-30+S	400	1	376,20
	-974199	3-503-S	30-3+S, 30-30+S	500	1	399,80



Die KUKKO-Universalabzieher mit schlanken Haken eignen sich besonders für enge Zwischenräume.

Die Abzughaken sind sehr schmal geschmiedet und enden in einer extrem schmalen Krallen. Sie können so unter Lager, Getriebezahnrädern, Ritzeln und Synchronkörper greifen, bei denen Standardhaken zu groß sind.

**31 Lenkradabzieher**  
 Steering wheel pullers  
 Arache-volant de direction  
 Extractores de volantes  
 Stuurwieltrekkers

Mercedes Type



LKW/trucks/camion

78	EAN-Code	Art.-No.	Ø mm		Euro
ST	4021176-				
	-013881	31-1	30-60	1	181,40
	-013966	31-2	80-90	1	210,70

**32 Lenkradabzieher**  
 Steering wheel pullers  
 Arache-volant de direction  
 Extractores de volantes  
 Stuurwieltrekkers

für Lenkräder mit Speichen  
 for wheels with spokes  
 pour volants à branches  
 para volantes con radios  
 voor wielen met spaken



78	EAN-Code	Art.-No.	mm		Euro
ST	4021176-				
	-014048	32-1	100	1	170,00
	-014123	32-2	120	1	185,40



**33 Lenkradabzieher** für Opel  
 Steering wheel pullers for Opel  
 Arache-volant de direction pour Opel  
 Extractores de volantes para Opel  
 Stuurwieltrekkers voor Opel

78 ST	<b>EAN-Code</b>	<b>Art.-No.</b>		<b>Euro</b>
	4021176-014208	33		

**34 Lenkradabzieher** **34-0** **34-1**  
 Steering wheel pullers  
 Arache-volant de direction  
 Extractores de volantes  
 Stuurwieltrekkers

*universal für GM und Opel  
 universal for GM and Opel  
 universel pour GM et Opel  
 universales para GM y Opel  
 universeel voor GM en Opel*

78 ST	<b>EAN-Code</b>	<b>Art.-No.</b>		<b>Euro</b>			
	-865879	34-0			GM 3/Opel	1	81,20
	-865886	34-1			Univ.	1	117,60
	-865893	34-E			Arme/arms/bras „Frontera“ für/for/pour No. 34-0	1	42,20

**38 Universal-Radnabenabzieher**  
 Universal hub puller  
 Arache-moyeux universel  
 Extractor universal de cubos de ruedas  
 Universele wielnaaftrekker

69 ST	<b>EAN-Code</b>	<b>Art.-No.</b>		<b>Euro</b>				
	4021176-014383	38			5-arm/5-bras	250	1	196,30
	-014468	38-1			Ⓐ Abzughaken/arm/griffe		1	17,90
	-014871	40-3-8			Ⓑ Zubehör/Accessories 40 + 38		1	17,50

**39-A Universal-Radfelgenabzieher**  
 Universal wheel rim puller

*komplett mit Kunststoffkoffer für Zubehör  
 complete with plastic case for accessory*

78 ST	<b>EAN-Code</b>	<b>Art.-No.</b>		<b>Euro</b>
	4021176-976520	39-A		

**40 Universal-Radnabenabzieher**  
 Universal hub puller  
 Arache-moyeux universel  
 Extractor universal de cubos de ruedas  
 Universele wielnaaftrekker

*Schlag-/Shock- Modell  
 Impact-/shock design  
 Coups de marteau exécution  
 Modelo golpe/choque  
 Slag-/schok-model*

69 ST	<b>EAN-Code</b>	<b>Art.-No.</b>		<b>Euro</b>				
	4021176-014611	40-3			3-arm/3-bras	225	1	187,00
	-014956	40-5			5-arm/5-bras	225	1	231,90
	-014796	40-3-1			Ⓐ Abzughaken, arm, griffe		1	21,50
	-014871	40-3-8	Ⓑ Zubehör/Accessories 40 + 38		1	17,50		

**41 2-armige Abzieher**  
 2-arm pullers  
 Extracteurs à 2 bras  
 Extractores de 2 brazos  
 2-armige trekkers

33 ST	<b>EAN-Code</b>	<b>Art.-No.</b>		<b>mm</b>		<b>mm</b>		<b>Euro</b>
	4021176-362859	41-0		60		40	1	27,40
	-015038	41-1		65		65	1	27,40
	-015113	41-2		80		80	1	31,90
	-787829	41-3		90		120	1	61,20
	-836268	41-4		130		160	1	93,50
	-836343	41-5		180		200	1	128,20

**42 3-armige Abzieher**  
 3-arm pullers  
 Extracteurs à 3 bras  
 Extractores de 3 brazos  
 3-armige trekkers

33 ST	<b>EAN-Code</b>	<b>Art.-No.</b>		<b>mm</b>		<b>mm</b>		<b>Euro</b>
	4021176-362026	42-0		60		40	1	36,20
	-015298	42-1		65		65	1	36,40
	-015373	42-2		80		80	1	43,90
	-787904	42-3		90		120	1	83,60
	-836428	42-4		130		160	1	123,00
	-836596	42-5		180		200	1	183,90

**41-B 2-arm/2-bras**  
**42-B 3-arm/3-bras**

**7 to hydraulic TECHNOLOGY**

78 ST	<b>EAN-Code</b>	<b>Art.-No.</b>		<b>mm</b>		<b>mm</b>	<b>to/KN</b>	<b>mit with/avec</b>		<b>Euro</b>
	4021176-887345	41-5-B		160		150	7/ 70	8-01	1	331,40
	-887352	42-5-B		200		150	7/ 70	8-01	1	361,50

**43 Kleinteilabzieher** **43-001** **43-011**  
 Small part puller  
 Extracteur de petites pieces  
 Extractor para piezas pequenas  
 Trekker voor kleine delen

69 ST	<b>EAN-Code</b>	<b>Art.-No.</b>		<b>mm</b>		<b>mm</b>	<b>a mm</b>	<b>b mm</b>	<b>Ø mm</b>		<b>Euro</b>
	4021176-913518	43-001		60		50	1,5	10	4,5	1	62,60
	-913501	43-011		60		50	1,5	10	4,5	1	79,40



### 43 2-armige Abzieher

2-arm pullers  
Extracteurs à 2 bras  
Extractores de 2 brazos  
2-armige trekkers

*selbstzentrierend  
self centering  
autocentreuse  
autocentrantes  
zelfcentrend*



66	EAN-Code	Art.-No.	mm	mm		Euro
ST	4021176-015458	43-1	60	50	1	37,50
	-015861	43-2	70	70	1	38,40
	-015946	43-3	80	80	1	39,50

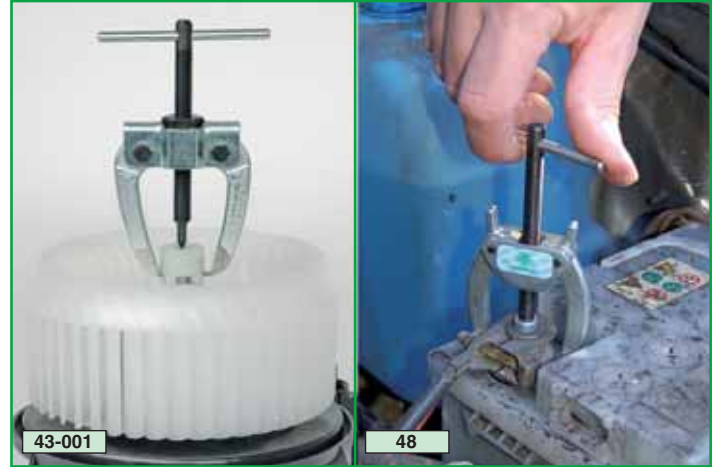

### 43 3-armige Abzieher

3-arm pullers  
Extracteurs à 3 bras  
Extractores de 3 brazos  
3-armige trekkers

*selbstzentrierend  
self centering  
autocentreuse  
autocentrantes  
zelfcentrend*



23	EAN-Code	Art.-No.	mm	mm		Euro
ST	4021176-015526	43-11	60	50	1	47,60
	-015601	43-12	70	70	1	48,40
	-015786	43-13	80	80	1	51,40

### 44 2-armige Abzieher

2-arm pullers  
Extracteurs à 2 bras  
Extractores de 2 brazos  
2-armige trekkers

*selbstzentrierend  
self centering  
autocentreuse  
autocentrantes  
zelfcentrend*

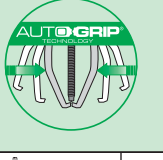

23	EAN-Code	Art.-No.	mm	mm		Euro
ST	4021176-016028	44-1	100	100	1	44,70
	-016103	44-2	120	120	1	69,90
	-016288	44-3	160	160	1	108,30
	-016363	44-4	250	200	1	141,40
	-815133	44-5	300	250	1	185,80
	-815218	44-6	375	275	1	316,40

### 45 3-armige Abzieher

3-arm pullers  
Extracteurs à 3 bras  
Extractores de 3 brazos  
3-armige trekkers

*selbstzentrierend  
self centering  
autocentreuse  
autocentrantes  
zelfcentrend*

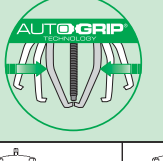

23	EAN-Code	Art.-No.	mm	mm		Euro
ST	4021176-016448	45-1	100	100	1	63,60
	-016516	45-2	120	120	1	95,20
	-016691	45-3	160	160	1	142,20
	-016776	45-4	250	200	1	201,00
	-815393	45-5	300	250	1	250,20
	-815478	45-6	375	275	1	326,30
	-821646	45-7	600	350	1	450,70

### 46 2-armige Abzieher

2-arm pullers  
Extracteurs à 2 bras  
Extractores de 2 brazos  
2-armige trekkers

15 to  
**hydraulic**  
TECHNOLOGY

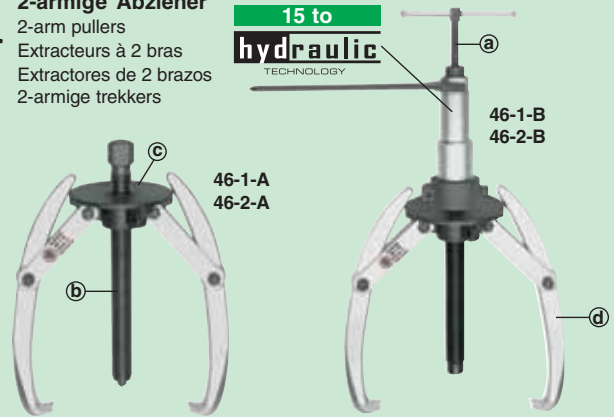

21	EAN-Code	Art.-No.	mm	mm		Euro
ST	4021176-016936	46-1-A	300	300	1	283,10
	-017193	46-2-A	500	450	1	355,40
	-017018	46-1-B	300	300	1	772,40
	-017278	46-2-B	500	450	1	841,90
	-034671	8-1-F	Ⓐ 46		1	505,40
	-169564	11-3-0	Ⓑ 46-1		1	75,20
	-017353	46-3-2	Ⓑ 46-2		1	68,20
	-016851	46-04	Ⓒ 46		1	96,20
	-017438	46-300	Ⓓ 46-1		1	64,20
	-170461	46-450	Ⓓ 46-2		1	72,80

### 47 3-armige Abzieher

3-arm pullers  
Extracteurs à 3 bras  
Extractores de 3 brazos  
3-armige trekkers

15 to  
**hydraulic**  
TECHNOLOGY

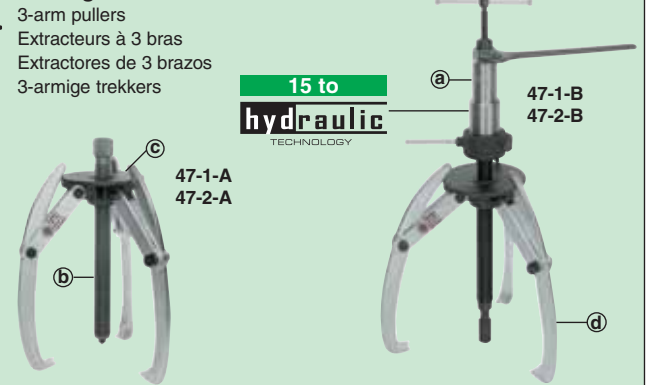

21	EAN-Code	Art.-No.	mm	mm		Euro
ST	4021176-017681	47-1-A	300	300	1	347,20
	-017841	47-2-A	500	450	1	432,70
	-017766	47-1-B	300	300	1	826,40
	-017926	47-2-B	500	450	1	906,80
	-034671	8-1-F	Ⓐ 47		1	505,40
	-169564	11-3-0	Ⓑ 47-1		1	75,20
	-017353	46-3-2	Ⓑ 47-2		1	68,20
	-016851	46-04	Ⓒ 47		1	96,20
	-017438	46-300	Ⓓ 47-1		1	64,20
	-170461	46-450	Ⓓ 47-2		1	72,80



### 48 Batterieklemmen-Abzieher

Battery terminal puller  
Arrache-cosses de batteries  
Extractor de bornes batería  
Accupoolklemtrekker



Einhand Modell  
One-Hand model  
Automatique pour une seule main  
Automático de una mano  
met een hand te bedienen systeem

64	EAN-Code	Art.-No.	mm	mm	Euro
ST	4021176-170539	48	60	40	38,00

### 49-0 Schraubenausdreher

Bolt extractors  
Extracteurs de vis cassés  
Extractores de tornillos  
Boutuitdraaiers

breit gerillte amerikanische Form  
Americah shape with broad flutes  
Modèle américain, à rainures larges  
Ejecución americana, estriado ancho  
Amerikaanse uitvoering, breed gegroefd



61	EAN-Code	Art.-No.	mm	"	Euro
ST	4021176-490569	49-01	3- 6	1/8 - 1/4	8,40
	-490644	49-02	6- 8	1/4 - 5/16	10,30
	-490729	49-03	8-11	5/16 - 7/16	10,30
	-490804	49-04	11-14	7/16 - 9/16	12,30
	-490989	49-05	14-18	9/16 - 3/4	12,80
	-491061	49-06	18-24	3/4 - 1	15,60

### 49-0-S Schraubenausdreher-Satz

Bolt extractor set  
Jeu d'extracteurs de vis cassés  
Juego de extractores de tornillos  
Boutuitdraaiers-set

breit gerillte amerikanische Form  
Americah shape with broad flutes  
Modèle américain, à rainures larges  
Ejecución americana, estriado ancho  
Amerikaanse uitvoering, breed gegroefd



61	EAN-Code	Art.-No.	mm	"	Euro
ST	4021176-491146	49-0-S	3-24	1/8 - 1	71,00

### 49 Schraubenausdreher

Bolt extractors  
Extracteurs de vis cassés  
Extractores de tornillos  
Boutuitdraaiers

fein gerillte deutsche Form  
shape with narrow flutes  
modèle allemand, à rainures fines  
ejecución alemana, estriado fino  
duitse uitvoering, fijn gegroefd



61	EAN-Code	Art.-No.	mm	"	Euro
ST	4021176-018008	49-1	3- 6	1/8 - 1/4	3,10
	-018183	49-2	6- 8	1/4 - 5/16	3,00
	-018268	49-3	8-11	5/16 - 7/16	3,40
	-018343	49-4	11-14	7/16 - 9/16	3,90
	-018428	49-5	14-18	9/16 - 3/4	4,80
	-018596	49-6	18-24	3/4 - 1	6,70
	-018671	49-7	24-33	1 - 1 3/8	10,60
	-018756	49-8	33-45	1 3/8 - 1 3/4	15,10
	-018831	49-9	45-52	1 3/4 - 2 1/8	31,50

### 49 Schraubenausdreher-Sätze

Bolt extractor sets  
Jeu d'extracteurs de vis cassés  
Juegos de extractores de tornillos  
Boutuitdraaiers sets

fein gerillte deutsche Form  
German shape with narrow flutes  
Modèle allemand, à rainures fines  
Ejecución alemana, estriado fino  
Duitse uitvoering, fijn gegroefd



61	EAN-Code	Art.-No.	mm	"	Euro
ST	4021176-018916	49-A	3-18	1/8 - 3/4	19,50
	-019098	49-B	3-24	1/8 - 1	26,60
	-019173	49-C	3-45	1/8 - 1 3/4	52,30

### 49-T

### Super Traction



61	EAN-Code	Art.-No.	mm	"	Euro
ST	4021176-758461	49-T-1	4- 5	1/8 - 1/4	4,80
	-758539	49-T-2	5- 7	1/4 - 5/16	5,00
	-758614	49-T-3	8-12	5/16 - 1/2	6,20
	-758799	49-T-4	12-14	1/2 - 5/8	7,50
	-758874	49-T-5	16-20	5/8 - 3/4	9,80

### 49-T-A

### Super Traction



61	EAN-Code	Art.-No.	mm	"	Euro
ST	4021176-758959	49-T-A	4-20	1/8 - 3/4	36,00

### 49-U-B Schraubenausdreher-Satz

Bolt extraction set  
Jeu d'extraction vis cassés  
Juegos de extracción tornillos  
Boutuitdraaiers set

mit Bohrern und Bohrbüchsen  
with drills and drill-guides  
avec forets et canons de perçage  
con brocas y casquillos de taladrar  
met boren en boorgeleidingsbussen



60	EAN-Code	Art.-No.	"	Euro
ST	4021176-799136	49-U-B	M 5 - M16	129,20

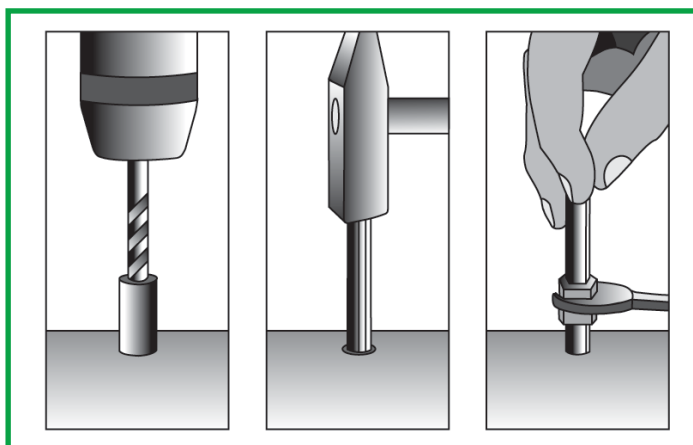





**49-U Schraubenausdreher** *mit Bohren und Bohrbüchse*  
 Bolt extractors *with drills and drill-guide*  
 Extracteurs de vis cassés *avec forets et canon de perçage*  
 Extractores de tornillos *con brocas y cascillo de taladrar*  
 Boutuitdraaiers *met boren en boorgeleidingsbus*

60	EAN-Code	Art.-No.		mm	"		Euro
ST	4021176-799549	49-U-11	M 5 - M 7	3,2	1/4	1	18,70
	4021176-799624	49-U-12	M 8 - M 9	4,8	3/8	1	25,10
	4021176-799709	49-U-13	M10	6,4	7/16	1	29,80
	4021176-799884	49-U-14	M12	8,0	1/2	1	36,20
	4021176-799969	49-U-15	M14 - M16	8,7	5/8	1	46,60

**50 Stehbolzen-Ausdreher**  
 Stud pullers  
 Dégoujonneuses  
 Extractores de espárragos  
 Tapeind-uitdraaiers  
*mit Innenverzahnung with internal serration avec denture intérieure con dientes interiores met binnenvertanding*

75	EAN-Code	Art.-No.	Ø mm	"		Euro
ST	4021176-019258	50-1	5-10	3/16 - 3/8	1	50,40
	4021176-019333	50-2	8-19	5/16 - 3/4	1	63,60
	4021176-019418	50-3	18-25	3/4 - 1	1	77,10

**51 Stehbolzen-Ausdreher** **Economy**  
 Stud pullers  
 Dégoujonneuses  
 Extractores de espárragos  
 Tapeind-uitdraaiers  
*mit Innenverzahnung with internal serration avec denture intérieure con dientes interiores met binnenvertanding*

75	EAN-Code	Art.-No.	Ø mm	"		Euro
ST	4021176-019586	51-1	5-10	3/16 - 3/8	1	43,10
	4021176-019661	51-2	8-19	5/16 - 3/4	1	50,70
	4021176-019746	51-3	18-25	3/4 - 1	1	62,30

**52 Stehbolzen-Ausdreher** *mit grossem Spannbereich extra wide working range avec capacité extra grande met alcance grande met extra groot spanbereik*  
 Stud puller  
 Dégoujonneuse  
 Extractor de espárragos  
 Tapeind-uitdraaier  
*mit Innenverzahnung with internal serration avec denture intérieure con dientes interiores met binnenvertanding*

75	EAN-Code	Art.-No.	Ø mm	"		Euro
ST	4021176-019821	52	5-19	3/16 - 3/4	1	85,50

**53 Stehbolzen-Ausdreher** *für enge Platzverhältnisse for confined spaces pour endroits exigues para intersticios angostos voor nauwe tussenruimtes*  
 Stud pullers  
 Dégoujonneuses  
 Extractores de espárragos  
 Tapeind-uitdraaiers

75	EAN-Code	Art.-No.	Ø mm		Euro
ST	4021176-342318	53-6	6	1	37,20
	4021176-866234	53-7	7	1	37,20
	4021176-342493	53-8	8	1	37,20
	4021176-342561	53-10	10	1	39,40
	4021176-342646	53-12	12	1	39,40
	4021176-984563	53-14	14	1	53,80
	4021176-388774	53-16	16	1	54,70
	4021176-966774	53-24	24	1	388,20
	4021176-966781	53-30	30	1	417,90

**53 Stehbolzen-Ausdreher-Satz**  
 Stud pullers set  
 Dégoujonneuses jeu  
 Extractores de espárragos juego  
 Tapeind-uitdraaiers set

*für enge Platzverhältnisse for confined spaces pour endroits exigues para intersticios angostos voor nauwe tussenruimtes*



75	EAN-Code	Art.-No.	Ø mm		Euro
ST	4021176-342233	53	6, 8, 10, 12	1	164,60

**Info**

**Pullback**  
TECHNOLOGY

Leichtes Rückziehen des Meißels aus der gesprengten Mutter, durch die Pull-back-Technologie. Kein Hängenbleiben! Der mit der Spindel verbundene Meißel wird, über eine Führungsschiene, im rechten Winkel in die Mutter gepresst, um sie zu zerschneiden. Nach dem Sprengen der Mutter lässt sich der Meißel durch die Verbindung mit der Spindel wieder leicht in die Ausgangsposition zurückdrehen.

**54 Mutternsprenger**  
 Nut splitters  
 Casse-écrous  
 Arancatuercas  
 Moerensplijters

*zweischneidig double-edged à deux tranchants de dos filés dubbelwerkend*

62	EAN-Code	Art.-No.	mm	"		Euro
ST	4021176-170614	54-2	10-27	13/32 - 1 1/16	1	76,00
	4021176-170799	54-3	17-36	1 1/16 - 1 7/16	1	98,40
	4021176-253041	54-2-M	@	Zubehör/Accessories	1	33,20
	4021176-253126	54-3-M	@	Zubehör/Accessories	1	46,30

**55 Mutternsprenger**  
 Nut splitters  
 Casse-écrous  
 Arancatuercas  
 Moerensplijters

62	EAN-Code	Art.-No.	mm	"		Euro
ST	4021176-019906	55-0	4-10	5/32 - 13/32	1	52,00
	4021176-020063	55-1	10-18	7/16 - 1 1/16	1	65,00
	4021176-020148	55-2	19-27	3/4 - 1 1/16	1	67,10
	4021176-020223	55-3	27-36	1 1/8 - 1 7/16	1	88,20
	4021176-020308	55-4	32-50	1 5/16 - 2	1	301,00
	4021176-252549	55-0-M	@	Zubehör/Accessories	1	12,30
	4021176-252624	55-1-M	@	Zubehör/Accessories	1	18,70
	4021176-252709	55-2-M	@	Zubehör/Accessories	1	20,20
	4021176-252884	55-3-M	@	Zubehör/Accessories	1	28,20
	4021176-252969	55-4-M	@	Zubehör/Accessories	1	47,90

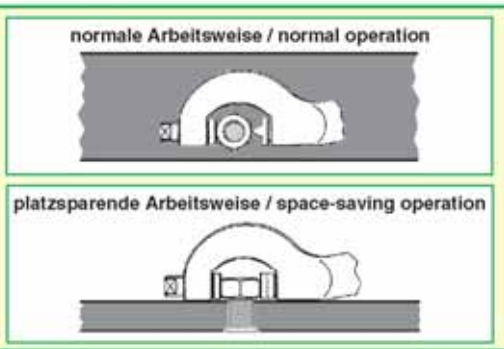

**56 Mutternsprenger** *mit hydraulischer Spindel*  
 Nut splitters *with hydraulic screw*  
 Casse-écrous *avec vis hydraulique*  
 Arancatuercas *con husillo hidráulico*  
 Moerensplijters *met hydraulische spindel*

**NEU · NEW**  
**60 + 70 Nm**  
**hydraulic**  
 TECHNOLOGY

62	EAN-Code	Art.-No.	mm	"	Edelstahl		Euro
ST	4021176-020483	56-1	7-24	9/32 - 15/16	-	1	154,40
	-020551	56-2	22-36	7/8 - 17/16	-	1	291,20
	-111501	56-3	27-46	1 1/8 - 1 13/16	bis Güte 10	1	366,70
	-253201	56-1-M	@	Zubehör/Accessories		1	15,60
	-253386	56-2-M	@	Zubehör/Accessories		1	34,20
	-111518	56-3-M	@	Zubehör/Accessories		1	55,00

**59 Kettensprenger-Satz**  
 Chain splitting and riveting tool  
 Outil de détachement de la chaîne et de rivetage

für einfache Rollenketten nach DIN 8187 und einem Bolzen-Ø von: 1,85 - 5,72 mm

62	EAN-Code	Art.-No.	Inhalt		Euro
ST	4021176-860207	KS-59-1/14	59-1 / 59-1-1 / 59-1-2 / 58-1	1	372,40
	800214	59-1	Grundgerät	1	210,00
	800221	59-1-1	Spannschraube für Ø 3,28-4,45 mm Abschlussplatte für Ø 3,28-4,45 mm Druckadapter für Ø 3,28-4,45 mm Führungsmutter für Ø 3,28-4,45 mm Bolzenanschlag für Ø 3,28-4,45 mm Ausdrückbolzen für Ø 3,28-4,45 mm	1 1 1 1 1 1	39,20
	800238	59-1-2	Spannschraube für Ø 5,08-5,72 mm Abschlussplatte für Ø 5,08-5,72 mm Druckadapter für Ø 5,08-5,72 mm Führungsmutter für Ø 5,08-5,72 mm Bolzenanschlag für Ø 5,08-5,72 mm Ausdrückbolzen für Ø 5,08-5,72 mm	1 1 1 1 1 1	44,80
	800245	58-1	Montagespanner für Ø 5,08-5,72 mm	1	84,00

**KS-63-1/5 Innenfederspanner-Satz Daimler**  
 Spring compressors set  
 Jeu de compresseurs de ressorts  
 Juego de compresores de muelles  
 Veerspanners set

ST	EAN-Code	Art.-No.	Inhalt		Euro
	4021176-800009	KS-63-1/5	63-1 / 63-1-A / 63-1-B	1	936,70

**63 Federhalter**  
 Jaws  
 Griffes  
 Garras  
 Trekkers

ST	EAN-Code	Art.-No.	für / for / pour		Euro
	4021176-800016	63-1	Grundgerät	1	348,70
	-800023	63-1-A	kleine Federhalterplatten	2	166,70
	-800030	63-1-B	große Federhalterplatten	2	166,70

**64 Federspanner**  
 Spring compressors  
 Compresseurs de ressorts  
 Compresores de muelles  
 Veerspanners

Deckt ca. 90% aller KFZ Modelle ab.

ST	EAN-Code	Art.-No.	a	Ø	Euro
	4021176-987281	64-1	mm 40-396	mm 80-200	1 826,00

**65/66 Federspanner**  
 Spring compressors  
 Compresseurs de ressorts  
 Compresores de muelles  
 Veerspanners

GS - Sicherheitsausführung  
 GS - Safety certificate  
 GS - Sécurité éprouvée  
 GS - Certificado de seguridad  
 GS - Veiligheid certif.

„Universal“ 65      „MacPherson“ 66

74	EAN-Code	Art.-No.	a	Ø	Euro
ST	4021176-020636	65-0	mm 200	mm 110-180	1 152,80
	-020711	65-1	300	110-180	1 158,20
	-020896	65-2	400	110-180	1 166,80
	-020971	66-1	100-250	110-180	1 190,30
	-170201	66-2	100-400	110-180	1 201,10
	-170386	66-3	100-400	110-180	1 238,80

### K-65-A KFZ-Universal-Werkstattgarnitur

Set of universal automotive repair shop tools  
Jeu universel pour ateliers automobiles  
Juego universal para taller de automóviles  
Universeel werkplaatsset voor personenwagens



79 ST	EAN-Code	Art.-No.	Satz/Set/Jeu		Euro
	4021176-412851	K-65-A	Univers.		



### 67 Federspanner-Satz

Set of spring compressors  
Jeu de compresseurs de ressorts  
Juego de compresores de muelles  
Veerspanners-set



ST	EAN-Code	Art.-No.	Ø mm	Inhalt contents		to		Euro
	-924279	67-1	80-195	67-01; 67-02	2+2	1,1		
	-924286	67-2	80-195	67-01; 67-02	2+2	2,25	1	713,80

### 67 Federhalter

Jaws  
Griffes  
Garras  
Trekkers



ST	EAN-Code	Art.-No.	für / for / pour			Euro
	-076527	67-01	Ø 80-145 mm	1		
	-076534	67-02	Ø 145-195 mm	2	1	223,90
	-076541	67-03	Ø 140-175 mm	2	1	223,90
	-076558	67-04	Ø 180-230 mm	2	1	223,90
	-076565	67-05	Ø 80-120 mm	1	1	131,90
	-076572	67-06	Ø 80-145 mm	2	1	223,90
	-099465	67-07	BMW E39/46	2	1	292,00
	-076514	67-08	MB C-Klasse Type 203	2	1	145,90
	-076521	67-09	MB E-Klasse Type 211	2	1	292,00
	-924538	67-10	Peugeot Break, Citroen C15	2	1	131,50
	-924552	67-12	Chrysler Grand Voyager	2	1	223,90

### 68 Federspanner für Federn an Motorradständer BMW, andere

Spring compressor  
Compresseurs de ressorts  
Compresores de muelles  
Veerspanner



ST	EAN-Code	Art.-No.		Euro
	-981678	68		

### Info



Die Seitenbolzen des Satzes 69-C lassen sich mit den Verlängerungen 19-1-P beliebig verlängern!



### 69 Kugellager-Abzieh-Sätze

Ball bearing extractor sets  
Jeu d'arrache-roulements à billes  
Juegos de extractores de cojinetes de bolas  
Kogellagertrekker sets

Universal/Universal  
Universal/Universal  
Universeel



48 ST	EAN-Code	Art.-No.	Satz/Set/Jeux für/for/pour		Euro		
	-781391	69-A	6004-6013; 6201-6206; 6300-6305			1	244,30
	-781476	69-B	6011-6020; 6206-6212; 6305-6309; 6403-6407			1	320,20
	-781544	69-C	6021-6032; 6213-6230; 6310-6321; 6406-6417			1	659,40

### 70 Kugellager-Abzieh-Sätze für Rillenkugellager

Ball bearing extractor sets für deep-groove ball bearings  
Jeu d'arrache-roulements pour roulements rainurés à billes  
Juegos de extracción para cojinetes de bolas ranurados  
Kogellagertrekker sets voor groefkogellagers



47 ST	EAN-Code	Art.-No.	Satz/Set/Jeux für/for/pour		Euro		
	-786754	70-K	6000-6013, 6200-6207, 6300-6306			1	556,20
	-022128	70-A	6000-6013, 6200-6212, 6300-6311, 6403-6408			1	991,20
	-320866	70-B	6014-6021, 6213-6222, 6312-6317, 6409-6415			1	1875,80

### 70 Kugellager-Abzieher und -Abzughakensätze

Ball bearing extractors and pulling arm sets  
Arrache roulements et jeux de griffes  
Extractores de cojinetes y juegos de garras  
Kogellagertrekker en trekhaken-sets



a) Abzieher/Extractor/Arrache/Extractor/Trekker

b) Haken/Arms/Griffes/Garras/Trekhaken

46 ST	EAN-Code	Art.-No.	passend zu suitable for/s/adaptant à		Euro
	-021138	70-1	a)		
	-021473	70-711	b) No. 70-1	1	55,60
	-021541	70-712	b) No. 70-1	1	67,90
	-021626	70-713	b) No. 70-1	1	67,90
	-021213	70-2	a)	1	72,80
	-021701	70-721	b) No. 70-2	1	92,70
	-021886	70-722	b) No. 70-2	1	92,70
	-021398	70-3	a)	1	143,50
	-021961	70-731	b) No. 70-3	1	170,00
	-022043	70-732	b) No. 70-3	1	170,00
	-316418	70-4	a)	1	201,00
	-320453	70-4730	b) No. 70-4	1	206,40
	-320521	70-4731	b) No. 70-4	1	287,90
	-320781	70-4733	b) No. 70-4	1	926,80
	-320606	70-4734	b) No. 70-4	1	204,80

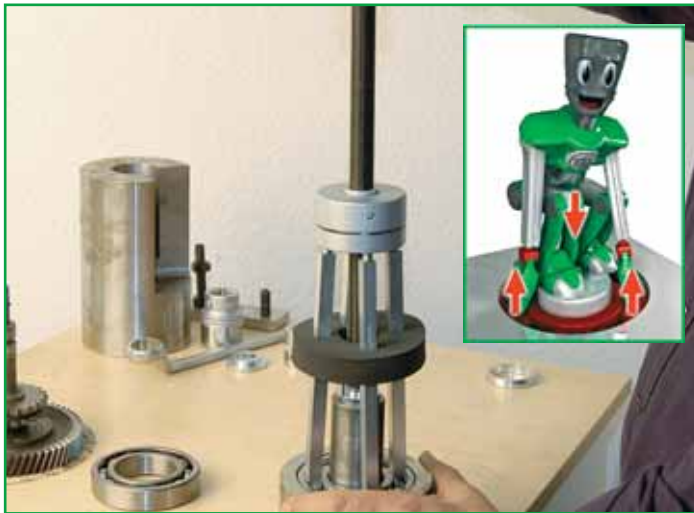

### KS-70-A-K Kugellager-Abzieh-Satz (Patent angemeldet)

Ball bearing extractor set  
Jeu d'arrache-roulements  
Juego de extracción  
Kogellagertrekker set  
Set di estrattori per cuscinetti

für Rillenkugellager  
for deep-groove ball bearings  
pour roulements rainurés à billes  
para cojinetes de bolas ranurados  
voor groefkogellagers  
per cuscinetti a sfera a gola profonda



ST	EAN-Code	Art.-No.			Euro
	4021176-956362	KS-70-A-K	6000-6012/6200-6212/6300-6311/6403-6408	1	1049,00

### 71 Lagereinbauwerkzeug-Satz

Bearing fitting tool kit  
Jeu d'outils pour la pose de roulements  
Juego de herramientas de montaje de cojinetes  
Set lagermontagegereedschap

Werkstattmodell, Stahl, **schwere Ausführung**  
workshop model, steel, **heavy deauty**  
pour l'utilisation à l'atelier, acier  
para uso en talleres, de acero  
werkplaats uitvoering, staal



49	EAN-Code	Art.-No.	Bohrungs-Ø mm	Aussen- Ø mm		Euro
ST	4021176-314841	71	10-50	26-110	1	1347,80

### 71-L Lagereinbauwerkzeugsatz

Bearing fitting tool kit  
Jeu d'outils pour la pose de roulements  
Juego de herramientas de montaje de cojinetes  
Set lagermontagegereedschap

leichtes Aussenmontagemodell  
light out on field model  
Exécution légère pour l'utilisation à l'extérieur  
Ejecución ligera para uso en montajes fuera de casa  
Lichte uitvoering voor montage buitenshuis



ST	EAN-Code	Art.-No.	33 Schlagringe Ø mm	3 Schlaghülsen Ø mm		Euro
	4021176-782121	71-L	10-50	18-32-52	1	642,70

### 97 Gewindefeilen

Thread files  
Limes pour filetage  
Limas para reparar roscas  
Draadvijlen



62	EAN-Code	Art.-No.	für/for/pour mm		Euro
ST	4021176-490231	97-1	DIN - ISO	1	64,20
	-490316	97-2	Whitworth + BSF	1	65,20
	-490491	97-3	SAE / UNF	1	66,80
	-720253	97-4	Whitworth G Rohrgewinde	1	68,20

### 98 Polradabzieher

Pulse wheel puller  
Extracteur générative  
Extractor dinamo



98-1

98-2



ST	EAN-Code	Art.-No.	L mm		Euro	
	4021176-433719	98-1	M27 x 1,0mm	55	1	21,80
	-433733	98-2	M26 x 1,5 mm + M22 x 1,5 mm	55	1	21,80

### 99 Gewindefeilsätze für Wellen

Thread protectors for shafts (DIN 322)  
Protège filetage pour arbre (DIN 322)  
Piezas para proteger rosca en ejes (DIN 322)  
Schroefdraadbeschermer voor assen (DIN 322)



ST	EAN-Code	Art.-No.	Satz/Set/Jeux für/for/pour		Euro
	4021176-908873	99-0	M 5 - M24	1	51,00

### 99 Aufziehbühler für Wellen (DIN 322)

Mounting attachments for shafts (DIN 322)  
Outillage pour montage sur arbre (DIN 322)  
Herramientas para ensamblar ejes (DIN 322)  
Gereedschap voor montage van toebehoeren an assen (DIN 322)



ST	EAN-Code	Art.-No.	Satz/Set/Jeux für/for/pour		Euro
	4021176-908880	99-1	M 5 - M24	1	486,70
	-908941	99-05	für/for/pour M 5	1	46,40
	-908958	99-06	für/for/pour M 6	1	46,40
	-908965	99-08	für/for/pour M 8	1	46,40
	-908997	99-10	für/for/pour M 10	1	46,40
	-908903	99-12	für/for/pour M 12	1	46,40
	-908910	99-16	für/for/pour M 16	1	46,40
	-908927	99-20	für/for/pour M 20	1	92,70
	-908934	99-24	für/for/pour M 24	1	61,80



### 100 Kolbenring-Spannbänder

Piston ring compressors  
Colliers pour segments  
Ceñidores de segmentos  
Zuigerveer-spanbanden



76 ST	EAN-Code 4021176-	Art.-No.	mm	mm	Euro
	-428203	100-0	40- 75	50	19,00
	-022203	100-1	57-125	80	29,60
	-022388	100-2	90-175	80	34,60
	-022463	100-3	90-175	165	59,00

### 101 Kolbenringzangen

Piston ring spreaders  
Pincas pour segments de pistons  
Tenazas de colocar segmentos  
Zuigerveertangen



76 ST	EAN-Code 4021176-	Art.-No.	Ø mm	mm	Euro
	-022531	101-1	50-100	200	27,40
	-022616	101-2	90-150	240	37,90

### 101-3 Universal-Kolbenring-Auflegezange

Universal piston ring spreader  
Pince pour segments de pistons universs.  
Tenaza de colocar segmentos universal  
Universele zuigerveertang  
Pinze universale per segmenti di pistoni

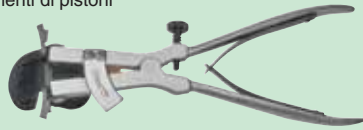

76 ST	EAN-Code 4021176-	Art.-No.	für pour / para / voor / per	Euro
	-974489	101-3	Ø 60 - 140 mm	176,20

### 102 Kolbenbolzen-Drücker

Piston pin driver  
Chasse-axes de pistons  
Botadores de bulones de pistones  
Zuigerpersen



76 ST	EAN-Code 4021176-	Art.-No.	Ø mm	Euro
	-170874	102-0	38	39,40
	-022791	102-1	100	129,20

### 103 Ventilfeder-Spannapparate

Valve lifters  
Lève-soupapes  
Compresores de muelles de válvula  
Klepveerlichters

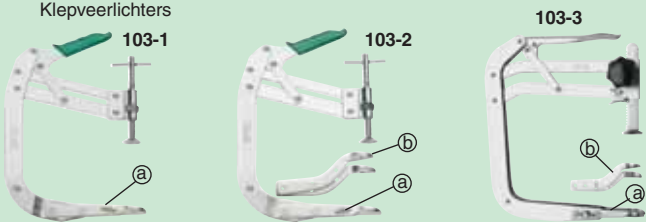

77 ST	EAN-Code 4021176-	Art.-No.	mm	Euro
	-022876	103-1	60-230	45,20
	-022951	103-2	40-230	60,20
	-023378	103-3	115-290	129,60
	-023033	103-101	Ⓐ für/for/pour 103-1/103-2	19,60
	-023118	103-201	Ⓑ für/for/pour 103-2	19,60
	-023453	103-301	Ⓒ für/for/pour 103-3	19,60
	-173929	103-401	Ⓑ für/for/pour 103-3	19,60

### 104 Bandschlüssel

Strap wrench  
Clé à sangle  
Llave de cinta abrazadora  
Bandsleutel



77 ST	EAN-Code 4021176-	Art.-No.	Ø mm	Euro
	-023606	104	180	29,60

### 105 Ölfilterschlüssel

Oil filter wrench  
Clé pour filtres à huile  
Llave para filtros de aceite  
Oliefiltersleutels



77 ST	EAN-Code 4021176-	Art.-No.	Ø mm	Euro
	-023866	105-0	70-110	39,80
	-175749	105-1	70-110	35,00

### 108 Ölfilterschlüssel

Oil filter wrench  
Clé pour à huile  
Llave para filtros de aceite  
Oliefiltersleutel

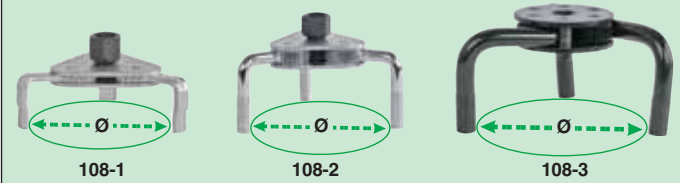

76 ST	EAN-Code 4021176-	Art.-No.	Ø mm	mm	mm	mm	Euro
	-760426	108-1	60-100	10 = 3/8"	12,5 = 1/2"	SW 21	34,20
	-965487	108-2	65-120	10 = 3/8"	12,5 = 1/2"	SW 21	34,20
	-967900	108-3	90-140	12,5 = 1/2"	12,5 = 1/2"		61,00

### 110 2-armige Abzieher, Techno

2-arm pullers  
Arrache roulements  
Extractores de 2 brazos  
2-armige trekkers

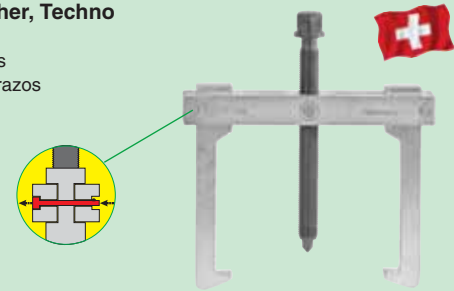

76 ST	EAN-Code 4021176-	Art.-No.	mm	mm	Euro
	-923753	110-01	50	50	36,40
	-923760	110-02	80	50	41,40
	-923777	110-1	100	100	56,00
	-923784	110-10	120	100	63,40
	-923791	110-2	160	150	78,00
	-923807	110-20	200	150	112,00
	-923814	110-3	250	200	194,70
	-956317	110-4	350	250	223,90

### INFOBOX: Hakensicherung / Non-slip device

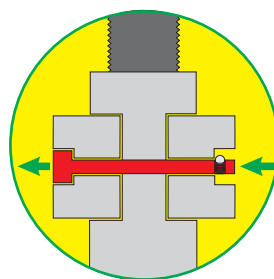



### 112 2-armige Abzieher

2-arm pullers  
Arrache roulements  
Extractores de 2 brazos  
2-armige trekkers

für Wälzlager  
for roller bearings  
à 2 bras  
para rolamientos  
voor rollagers



50	EAN-Code	Art.-No.	mm	mm	Euro
ST	4021176-418143	112-1	55	45	77,50
	-418891	112-10	65	70	85,00
	-419218	112-2	90	70	92,70
	-420283	112-20	100	100	108,30
	-420368	112-3	185	165	177,80
	-421358	112-4	250	250	386,30

### 113 3-armige Abzieher

3-arm pullers  
Arrache roulements  
Extractores de 3 brazos  
3-armige trekkers

für Wälzlager  
for roller bearings  
à 3 bras  
para rolamientos  
voor rollagers



50	EAN-Code	Art.-No.	mm	mm	Euro
ST	4021176-422423	113-20	125	100	162,30
	-422751	113-3	185	165	301,40
	-422188	113-4	230	250	462,00
	-423178	113-5	300	250	470,80

### 114 Auspuffrohabschneider

Exhaust-Pipe Cutter  
Coupe-tuyau d'échappement  
Cortador de tubos de escape  
Uitlaat-pijpsnijder



ST	EAN-Code	Art.-No.	Ø mm	Euro
	4021176-892400	114-1	80	133,10
	-892394	114-001	Ersatzkette/ Spare/ Rechange	79,90

### 116-20 Abklemmvorrichtung für Kfz-Schlauchleitungen

Clipping device for fluid hoses  
Dispositif de déblocage de tuyauteries flexibles automobiles  
Dispositivo de cierre con clip para mangueras  
Afklmgereedschap voor luxe wagen slangen



ST	EAN-Code	Art.-No.	Für / for / pour / para / per Ø mm	Euro
	4021176-971631	116-20	5 - 20	8,60

### 118 Abzieher für Nockenwellenräder

Puller for cam wheels  
Extracteur de pignons de distribution  
Extractor de engranajes de mando del árbol de levas  
Trekker voor nokkenastandwielen

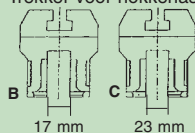

VW/Audi

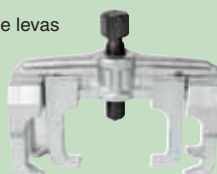

66	EAN-Code	Art.-No.	für/for/pour	Euro
ST	4021176-860904	118-0	TDI (4-6-8 Zyl.), V6, V8	196,30
	-989636	118-1	FSI, 2 LITER	156,80

### 119 Klemmfederspreizer

Clamp spring spreader  
Écarteur de ressorts de retenue  
Extensor de muelle opresor  
Klemveerspanner

für VW-Auspuffanlagen  
for VW-exhaust system  
pour systèmes d'échappement VW  
para instalaciones de gases de escape VW  
voor VW-uitlaatsystemen

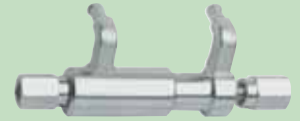

66	EAN-Code	Art.-No.	Euro
ST	4021176-248368	119-0	77,50

### 119 Klemmfeder Spannkeile Satz

Set of clamp spring tension wedges  
Jeu de coins de serrage pour ressorts  
Juego de cuñas de apretar de muelle  
Klemveerspanspie-set

für VW-Auspuffanlagen  
for VW-exhaust system  
pour systèmes d'échappement VW  
para instalaciones de gases de escape VW  
voor alle VW-uitlaatsystemen



66	EAN-Code	Art.-No.	Euro
ST	4021176-365904	119-1	48,30

### 120 2-armige Abzieher, Vario

2-arm pullers  
Arrache roulements  
Extractores de 2 brazos  
2-armige trekkers



ST	EAN-Code	Art.-No.	mm	mm	Euro
	4021176-918551	120-1	100	100	56,40
	-918599	120-10	125	100	63,40
	-918636	120-2	150	150	102,40
	-918674	120-20	200	150	115,40
	-918711	120-3	250	200	157,80
	-918759	120-30	350	200	201,80
	-918575	120-1-150	100	150	66,20
	-918612	120-10-150	125	150	73,20
	-918650	120-2-100	150	100	78,00
	-918698	120-20-200	200	200	129,80
	-918735	120-3-150	250	150	138,20
	-918773	120-30-150	350	150	175,20

### 120-ST Verkaufs- und Werkstattständer Economy

Sales display and workshop stand  
Stand de vente et d'atelier  
Caballete de exhibición y de talleres  
Verkoop- en werkplaatsstandaard



ST	EAN-Code	Art.-No.	Inhalt contents/contentu/inhoud	Euro
	4021176-961489	120-ST	120-1, 120-10, 120-2, 120-20, 120-3	495,10



### 120 + 2-armige Abzieher, Vario plus

2-arm pullers  
Arrache roulements  
Extractores de 2 brazos  
2-armige trekkers

**QUICK adjust**  
TECHNOLOGY



ST	EAN-Code	Art.-No.	mm	mm	Euro
	4021176-				
	-918568	120-1+	100	100	63,40
	-918605	120-10+	125	100	70,20
	-918643	120-2+	150	150	109,10
	-918681	120-20+	200	150	122,40
	-918728	120-3+	250	200	168,00
	-918766	120-30+	350	200	208,30
	-918582	120-1-150+	100	150	73,20
	-918629	120-10-150+	125	150	79,90
	-918667	120-2-100+	150	100	84,60
	-918704	120-20-200+	200	200	137,80
	-918742	120-3-150+	250	150	145,10
	-918780	120-30-150+	350	150	168,70

### 123 Ausdrückhebel für Scheibenbremsbeläge

Disk brake pad remover  
Lever pour la dépose de garnitures de freins à disques  
Palanca expulsora para forros de frenos de disco  
Hefboom voor schijfremblokken

123



123-2



123-3

72	EAN-Code	Art.-No.		Euro
ST	4021176-			
	-270789	123	Mercedes	33,40
	-826443	123-2	400 x 14	30,70
	-826511	123-3	400 x 17	38,70

### 124 Abzieher für Schwingungsdämpfer

Puller for vibration damper  
Extrateur de oscillation

124-20-B = **8 to**  
**hydraulic**  
TECHNOLOGY

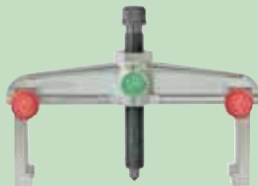

ST	EAN-Code	Art.-No.	Ø mm	für, for, pour, para	Euro
	4021176-				
	-985140	124-20-A	200	VW T4, VAG Transporter (96)	141,00
	-985133	124-20-11-P		Klauen, claws, griffes	80,70
	-985157	124-20-B	225	VW T4, VAG Transporter (96)	338,20
	-983771	02020203		Traverse, cross beam	PG5
	-034343	800		Hydraulik	133,40
	-985133	124-20-11-P		Klauen, claws, griffes	80,70
	-985164	124-20-U	45-200	universal	123,20
	-985119	124-20-01-P		Klauen, claws, griffes	53,80

Modell bestellen unter:  
Z-LKW-07-1 PG3



### 124-K PKW-Riemenscheibenabzieher-Satz

Passenger car V-belt pulley puller Set  
Jeu d'extraction de poulies de voitures  
Juego de extracción poleas de correas  
Trekkerzet voor v-riempeelies



für alle Fahrzeugtypen  
for all passenger car types  
pour poulies de tous genres  
para automóviles de todos tipos  
voor alle personen- en bestelwagens

67	EAN-Code	Art.-No.	Euro
ST	4021176-	124-K	193,20
	-736841		

### 125 Einziehvorrückung für Dichtringe

Oil seal installing tool  
Appareil à poser les joints d'étanchéité  
Pieza para colocar retenes  
Inzetgereedschap voor afdichtringen  
an luftgekühlten VW-Motoren  
on air-cooled VW-engines  
pour moteurs VW à refroidissement par air  
para motores VW refrigerados por aire  
voor alle luchtgekoelde VW-motoren



67	EAN-Code	Art.-No.	für/for/pour	Euro
ST	4021176-	125	VW	45,90
	-171604			

### 126-00 Kolbenrücksetzvorrückung

Piston reset tool  
Dispositif de rappel de pistons  
Dispositivo de retroceso de émbolo  
Remzuiger-terugstelgereedschap

für Scheibenbremsen  
for disk brakes  
pour freins à disques  
para frenos de disco  
voor schijfremmen



73	EAN-Code	Art.-No.	Euro
ST	4021176-	126-00	121,20
	-487774		

### 126-01 Ausziehhaken für Bremsbeläge

Brake pad remover  
Griffes d'extraction de garnitures de freins  
Garras de extracción forros de freno  
Trekhaak voor remblokken

für Scheibenbremsen  
for disk brakes  
pour freins à disques  
para frenos de disco  
voor schijfremmen

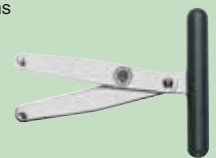

73	EAN-Code	Art.-No.	Euro
ST	4021176-	126-01	12,70
	-496271		

### 126-02 Bremskolbenklammer

Brake piston clamp  
Agrafe pour pistons de freins  
Clip de émbolo de freno  
Remzuigerklem



73	EAN-Code	Art.-No.	Euro
ST	4021176-	126-02	9,80
	-496356		



**126-03 Kolbendrehzange**  
 Piston-rotating pliers  
 Pince pour faire tourner les pistons  
 Pinza para girar émbolos  
 Handrem-terugsteltang  
*für Scheibenbremsen  
 for disk brakes  
 pour freins à disques  
 para frenos de disco  
 voor schijfremmen*



73 ST	EAN-Code	Art.-No.	1	Euro
	4021176- -496431	126-03		

**126-04 Bremsattel-Bürste**  
 Brake caliper brush  
 Brosse pour étriers de freins  
 Cepillo para pinza de freno  
 Remzadelborstel



73 ST	EAN-Code	Art.-No.	5	Euro
	4021176- -534881	126-04		

**126-10 Bremsattelwerkzeug-Sortiment**  
 Brake caliper tools set  
 Outillage pour étriers de frein  
 Herramienta para pinza-soporte  
 Compleet set remzadelgereedschap  
*für Scheibenbremsen  
 for disk brakes  
 Jeu pour freins à disques  
 Juego para frenos de disco  
 voor schijfremmen*



73 ST	EAN-Code	Art.-No.	Satz/Set/Jeu	1	Euro
	4021176- -534966	126-10	126-00, 126-01, 126-02, 126-03, 126-04, 127		

**126-20 Kolbenrückstellwerkzeug-Satz**  
 Brake piston reset tools set  
 Outillage de rappel de pistons de freins  
 Herramientas para retroceso del émbolo  
 Remzuigerterugstelgereedschap  
*für Scheibenbremsen  
 for disk brakes  
 Jeu pour freins à disques  
 Juego para frenos de disco  
 Assortiment voor schijfremmen*



126-30  
Opel

72 ST	EAN-Code	Art.-No.	Satz/Set/Jeu	1	Euro	
	4021176- -509636	126-20	6 Adapt.			215,20
	-891656	126-30	7 Adapt.			233,20
	-889752	126-208	Adapt. Opel			36,40

**126-40 Bremskolben-Rücksetz-Werkzeug-Satz**  
 Brake piston reset tools set  
 Outillage de rappel de pistons de freins  
 Herramientas para retroceso del émbolo  
 Remzuiger-terugstelgereedschap  
*für Scheibenbremsen  
 for disk brakes  
 Jeu pour freins à disques  
 Juego para frenos de disco  
 Assortiment voor schijfremmen*



73 ST	EAN-Code	Art.-No.	Satz/Set/Jeu	1	Euro
	4021176- -920370	126-40	9 Adapt.		

**126 Bremskolben-Rücksetz-Werkzeug-Satz**  
 Brake piston reset tools set  
 Outillage de rappel de pistons de freins  
 Herramientas para retroceso del émbolo  
 Remzuiger-terugstelgereedschap  
*für Scheibenbremsen  
 for disk brakes  
 Jeu pour freins à disques  
 Juego para frenos de disco  
 Assortiment voor schijfremmen*



73 ST	EAN-Code	Art.-No.	Satz für: / Set for: / Jeu pour:	1	Euro
	4021176- -974496	126-Ford-05	C-Max, Mondeo, Focus, Galaxy, Scorpio		



**127 Bremsattelifeile**  
 Brake caliper file  
 Lime pour étriers de freins  
 Limas para pinzas de freno  
 Remzadelvijl



73 ST	EAN-Code	Art.-No.	2	Euro
	4021176- -492051	127		

**127 Kugelgelenkabzieher**  
 Ball joint extractor  
 Arrache-rotule  
 Extractor de rótulas  
 Kogelgewricht-trekker  
*für, for, para, pour  
 Mercedes Sprinter,  
 VW-LT ab Bj. 1998  
 Ducato ab Bj. 1994*

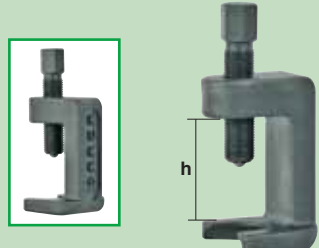

73 ST	EAN-Code	Art.-No.	mm	h	1	Euro
	4021176- -981784	127-3	34	63		

**Sie finden unser umfangreiches Schlüssel-Programm ab Seite 68.**  
 You can find our wide range of spanners from page 68.







### 128-F-SW Universal-Wischerarmabzieher

Universal whiper-arm puller  
 Extracteur universel d'essuie-glace  
 Extractor universal de brazos de limpiaparabrisas  
 Universele trekker voor ruitenwisserarmen  
 Estrattore universale di tergicristalli



EAN-Code	Art.-No.	mm	mm	Euro
4021176-971242	128-F-SW	60	50	65,00

### 128 Kugelgelenkabzieher

*Mercedes Ausführung*

Ball joint extractors  
 Arrache-rotules  
 Extractores de rótulas  
 Kugelgewricht-trekkers

*Mercedes type*  
*Model Mercedes*  
*Modelo Mercedes*  
*Mercedes uitvoering*



EAN-Code	Art.-No.	mm	Euro
4021176-024108	128-1	18	38,40
4021176-024283	128-2	23	52,60
4021176-024368	128-3	29	70,00
4021176-024443	128-4	39	87,80
4021176-024511	128-5	50	103,90

### 128 Kugelgelenkabzieher

Ball joint extractor  
 Arrache-rotule  
 Extractor de rótulas Cayenne  
 Kugelgewricht-trekker



EAN-Code	Art.-No.	mm	Euro
4021176-955556	128-TC	33	108,20

## TIPP: 128-4, 128-5, 129-5

- Durch Austausch der mechanischen Spindel gegen Adapter 800-801 können diese mechanischen Abzieher auch mit der hydraulischen Spindel 801 eingesetzt werden.
- By fitting adapter 800-801 in place of the mechanical screws, hydraulic screw No. 801 can be used for hydraulic operation of these pullers.
- Le remplacement de la vis mécanique par pièce de réduction 800-801 permet aussi le fonctionnement hydraulique avec vis hydraulique 801.
- Con pieza de reducción 800-801 se puede usar tambien husillo hidráulico No. 801 para modo de trabajo hidráulico.
- Met reduceerstuk 800-801 kunnen deze trekkers ook met hydraulische spindel nr. 801 gebruikt worden.
- Con raccordo di riduzione Num. 800-801 la vite idraulica Num. 801 viene semplicemente inserita al posto della vite meccanica.

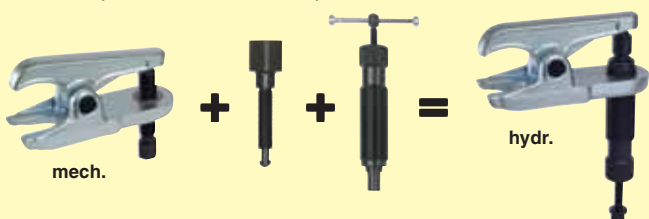

$$\begin{array}{l}
 128-4 + 800-801 + 801 \\
 128-5 + 800-801 + 801 \\
 129-5 + 800-801 + 801
 \end{array}
 \left. \vphantom{\begin{array}{l} 128-4 \\ 128-5 \\ 129-5 \end{array}} \right\} = \text{hydr.}$$

### 129 Kugelgelenk-Ausdrücker

Adjustable ball joint extractors  
 Arache-rotules  
 Extractores de rótulas  
 Trekkers voor kogelgewrichten

129-0  
 129-0-25  
 129-0-29  
 129-0-DC-1  
 129-0-DC-2

hebelübersetzt  
 lever type  
 Modèles avec levier  
 Tipo con leva  
 met heveloverbrenging



129-2

129-3  
 129-4

129-3-A  
 129-3-A-32  
 129-3-A-34

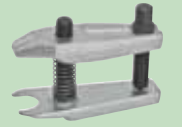

EAN-Code	Art.-No.	mm	Euro
4021176-410536	129-0	20	114,30
4021176-989667	129-0-25	VAG, univers., kleinere Modelle	114,30
4021176-989674	129-0-29	Polo (02), Golf (04/05), Caddy, A 2 (01) A 6 ( 98), A 8 (94), Passat (06), TT (99) Touran (04), LT (97) u. a.	114,30
4021176-923920	129-0-DC-1	MERCEDES C	133,20
4021176-923647	129-0-DC-2	SMART	117,00
4021176-024696	129-1	18-22	77,80
4021176-923654	129-1-B-1	BMW	94,00
4021176-024771	129-2	16-22-32	96,70
4021176-803178	129-3-A	ALU	118,60
4021176-989681	129-3-A-32	ALU-Fahrwerke, A 8 ab 03 (hinten)	118,60
4021176-989698	129-3-A-34	ALU-Fahrwerke, A 8 ab 03 (vorne)	118,60
4021176-270949	129-3	34	106,00
4021176-271021	129-4	40	134,80

### 129-25 Universal-Kugelgelenk-Ausdrücker

Universal adjustable ball joint extractors  
 Universal arache-rotules  
 Universel extractores de rótulas  
 Universeel trekkers voor kogelgewrichten  
 Universale

auch für alle italienische PKW Typen  
 also including all italian car types  
 aussi pour tous les types de voitures italiennes  
 tambien para todos modelos italianos  
 incl. alle italiaanse auto modellen  
 anche per tutti modelli italiani

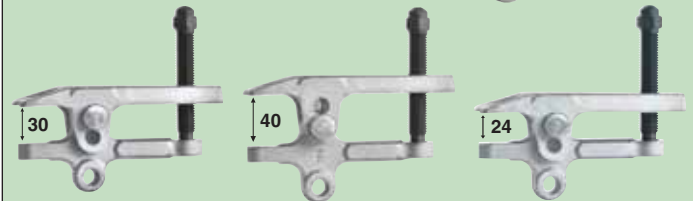
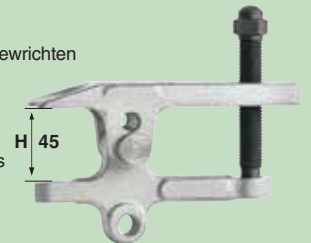

EAN-Code	Art.-No.	mm	H mm	Euro
4021176-967924	129-25	19	24, 30, 40, 45	102,20

### 129-3-H

### 129-4-H Kugelgelenk-Ausdrücker

Adjustable ball joint extractors  
 Arache-rotules  
 Extractores de rótulas  
 Trekkers voor kogelgewrichten



mit hydraulischer Spindel  
 with hydraulic screw  
 avec vis hydraulique  
 con husillo hidráulico  
 met hydraulische spindel



10 + 15 to  
**hydraulic**  
 TECHNOLOGY

EAN-Code	Art.-No.	mm	to	Euro
4021176-803253	129-3-H	30-34	10	247,20
4021176-803666	129-4-H	36-40	15	419,00



### 129-36 Spur- und Schubstangengelenk-Abzieher **NEU-NEW**

**Der Problemlöser für Citro**

Schwere LKW's und Niederflrbusse  
Heavy universal truck and ow-floor buses  
Modèles univers. pour camions et autobus  
Modelos universales para camiones, bus  
Univ. uitvoering voor vrachtwagens, bus



**10 to**  
**hydraulic**  
TECHNOLOGY

129-36-H



ST	EAN-Code	Art.-No.	mm				Euro
	4021176-						
	-865077	129-36	36	60	mech.	1	520,00
	-222894	129-36-H	36	60	hydr. 10 to	1	1320,00

### 129-5 Kugelgelenk-Ausdrücker

Adjustable ball joint extractors  
Arache-rotules  
Extractores de rótulas  
Trekkers voor kogelgewrichten

Schwere LKW's, Universal Modell z.B. Bau-LKW, Actros, MAN etc.  
Heavy universal truck model  
Modèles univers. pour camions  
Modelos universales para camiones  
Univ. uitvoering voor vrachtwagens

129-5-H

**15 to**  
**hydraulic**  
TECHNOLOGY



71	EAN-Code	Art.-No.	mm				Euro
	4021176-						
	-865084	129-5	36		mech.	1	252,20
	-865091	129-5-H	36		hydr. 15 to	1	476,40

### 129-5-45 Spur- und Schubstangengelenk-Abzieher **NEU-NEW**

Schwere LKW's, Busse, Niederflrbusse von  
Heavy universal truck, buses, low-floor buses  
Modèles univers. pour camions, autobus,  
Modelos universales para camiones, bus  
Univ. uitvoering voor vrachtwagens, bus  
DAF, IVECO, MAN, Mercedes Benz, Renault, Scania, Volvo

129-5-5



**10 / 20 to**  
**hydraulic**  
TECHNOLOGY

129-5-45-H10  
129-5-45-H20



ST	EAN-Code	Art.-No.	mm				Euro
	4021176-						
	-333316	129-5-45	45	120	mech.	1	315,10
	-333361	129-5-45-H10	45	120	hydr. 10 to	1	1100,00
	-333422	129-5-45-H20	45	120	hydr. 20 to	1	1280,00

129-36-H

+

**YHP-321**  
(siehe Seite /look page 65)

129-5-45-H10  
129-5-45-H20

### 129 LKW-Kugelgelenkabzieher **Universal**

Ball joint extractor for trucks  
Arrache-rotules pour camions  
Extractor de rótulas de camiones  
Kogelgewicht-trekker voor vrachtwagens

Schweres Werkstattmodell  
Heavy workshop model  
Exécution robuste pour l'atelier  
Ejecución pesada para talleres  
Zware werkplaats uitvoering



72	EAN-Code	Art.-No.	mm			Euro
	4021176-					
	-871191	129-6	25, 32, 47			833,10

### 130 3-armige Abzieher, Vario

3-arm pullers  
Arrache roulements  
Extractores de 3 brazos  
3-armige trekkers



ST	EAN-Code	Art.-No.	mm	mm		Euro
	4021176-					
	-918834	130-10	110	100	1	79,10
	-918872	130-2	150	150	1	125,10
	-918919	130-20	200	150	1	157,60
	-918957	130-3	250	200	1	245,60
	-918858	130-10-150	110	150	1	93,10
	-918896	130-2-100	150	100	1	111,20
	-918933	130-20-200	200	200	1	199,20
	-918971	130-3-150	250	150	1	224,70

### 130+ 3-armige Abzieher, Vario plus

3-arm pullers  
Arrache roulements  
Extractores de 3 brazos  
3-armige trekkers

**Quick adjust**  
TECHNOLOGY

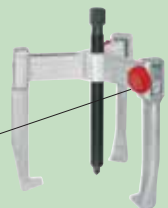

ST	EAN-Code	Art.-No.	mm	mm		Euro
	4021176-					
	-918841	130-10+	110	100	1	89,10
	-918889	130-2+	150	150	1	135,00
	-918926	130-20+	200	150	1	167,40
	-918964	130-3+	250	200	1	209,10
	-918865	130-10-150+	110	150	1	102,80
	-918902	130-2-100+	150	100	1	121,40
	-918940	130-20-200+	200	200	1	209,10
	-918988	130-3-150+	250	150	1	234,60

### 131-KS Universal-Karosserie-Ausbeul-Satz

Universal car body bump-out set  
Jeu universel de débosseleur de carrosseries  
Juego universal para saccar bollios de carrocería  
Universeel carrosserie uitdeukset  
Set universale per raddrizzare la carrozzeria



**Wellendraht einzeln nachbestellbar!**

ST	EAN-Code	Art.-No.	Inhalt		Euro
	4021176-		contents/contenu/inhoud		
	-961588	131-KS	<b>komplett</b>	1	576,70
	-957291	22-01-14	Schlagausziehvorrichtung	1	138,80
	-957215	131-01	Zughaken für Anschweißscheiben	1	32,60
	-957222	131-02	Zugklemme für Anschweißplatten und Bleche	1	57,40
	-957239	131-03	Ausziehklau mit 6 Greifern für Wellendraht	1	173,10
	-957246	131-04	Ausziehklau mit 10 Greifern für Wellendraht	1	188,60
	-957253	131-05	Wellendrahtprofile (50 Stck.)	1	41,40





### 132-A Karosserie-Schnellausbeulhebel

Car body bump-out lever  
 Levier de débossleur rapide de carrosseries  
 Palanca para saccar rápido bollios de carrocería  
 Hefboom voor snel uitdeuken van carrosserie  
 Leva rapida per raddrizzare la carrozzeria

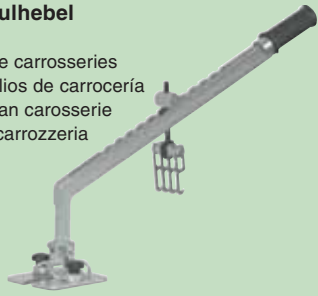

ST	EAN-Code	Art.-No.	Inhalt contents/contenu/inhoud		Euro
	4021176-957277	132-A	Schnellausbeulhebel, komplett	1	439,50
	957260	132-1	Hebel und Abziehklaue mit 4 Greifern	1	409,20
	961595	132-0021	Verbindungsstück für Zughaken + Zugklemme	1	9,20

### 134 Ablösehebel für Fahrzeug-Türverkleidung

Detaching tool for car-dor inside panel  
 Levier de décollement d'habillage de portes de véhicules  
 Herramienta de separación para panel interior de puerta de coche  
 Demontage hendel voor portierbekleding  
 Estrattore per pioli

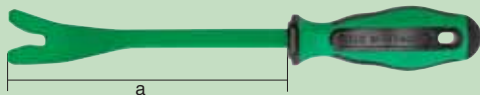

ST	EAN-Code	Art.-No.	a mm	L mm		Euro
	4021176-974502	134	175	285	1	18,70

### 135 Trenngabeln

Fork separators  
 Décolleurs à fourches  
 Separadores de horquilla  
 Demontagevorken



70 ST	EAN-Code	Art.-No.	c mm		Euro
	4021176-024856	135-1	18	1	49,10
	-024931	135-2	23	1	52,80
	-025013	135-3	29	1	54,30
	-025198	135-4	39	1	59,50
	-220531	135-5	45	1	69,20

### 139 Keilauszieh-Zange

Key-lifter  
 Pince arrache-clavettes  
 Pinza extractora de chavetas  
 Spie-uittrekker

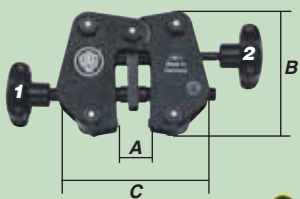

für Keile in Nuten  
 for keys of slots  
 pour clavettes bloquées  
 para chavetas que asientan firmemente  
 voor in de spiegleuf vastzittende spieen

43 ST	EAN-Code	Art.-No.	A mm	B mm	C mm	Hub mm		Euro
	4021176-869600	139-1	0-35	110	122-144	4	1	565,20

### 140 Micro-Abzieher

Small-part pullers  
 Extracteur pour mécanique de précision  
 Extractor para mecánica de precisión  
 Trekker voor fijnmechanika

z.B. für Tachowellen, Manometeren, Uhren, Modellbau u.ä.  
 e.g. for speedometer cable puller  
 p. ex. pour flexibles detachymètres  
 p. ej. para árboles flexibles de tacómetros  
 bijv. voor tachograafassen

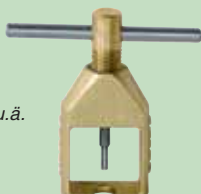

ST	EAN-Code	Art.-No.		mm		mm		Euro
	4021176-266720	140-1		10		10	1	14,60
	-266737	140-2		15		15	1	14,60
	-266751	140-3		18		18	1	14,60

### 140 Micro-Abzieher-Satz

Small-part pullers, set  
 Extracteur pour mécanique de précision  
 Extractor para mecánica de precisión  
 Trekker voor fijnmechanika

3-teilig/parts  
 140-1  
 140-2  
 140-3



ST	EAN-Code	Art.-No.		mm		mm		Euro
	4021176-951138	140-S		10-18		10-18	1	42,00

### KS-142/6 Universal-Scheibenwischer-Abziehersatz

Universal wiper arm puller set  
 Jeu universel d'extracteurs de bras d'essuie-glaces  
 Juego de extractores para brazos de limpiaparabrisas  
 Univ. trekker set voor ruitenwisser-armen

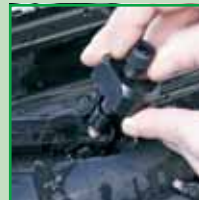

Kompletter Satz für VW, Audi, Seat, Skoda bis BJ 2008 und andere  
 Complete Set for VW, Audi, Seat, Skoda up to 2008 and other  
 Juego completo para VW, Audi, Seat, Skoda a año de construcción 2008 et alii  
 Jeu complete pour VW, Audi, Seat, Skoda jusque année de construction 2008 et alii

ST	EAN-Code	Art.-No.	Inhalt contents / contenu / inhoud		Euro
	4021176-555565	KS-142/6	142-1; 142-2; 142-3; 142-4; 128-F-SW; 43-1	1	407,50

### TIPP: 142-1; 142-2; 142-3; 142-4

- Abziehen der Scheibenwischerarme ohne Demontage der Motorhaube.
- **Hohe Belastbarkeit**, da aus **Vollmaterial** und aus einem Teil gefräst.
- Keine Beschädigung von Wischerarm, Welle etc.!
- Kein Verkratzen des Lacks!  
Keine Glasbeschädigung!

**KUKKO-Wischerarm-Adapter** sind **extrem belastbar**, da sie aus vollem, hochwertigen **Chrom-Vanadium-Stahl** bestehen und aus einem Teil gefräst werden.



**Das passiert beim KUKKO-Wischerarm-Adapter NICHT!**

### 142 Universal-Scheibenwischer-Abzieher

Universal wiper arm puller  
 Universal d'extracteurs de bras d'essuie-glaces  
 Extractores para brazos de limpiaparabrisas  
 Univ. trekker voor ruitenwisser-armen

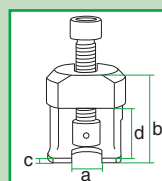

ST	EAN-Code	Art.-No.	a mm	b mm	c mm	d mm		Euro
	4021176-555572	142-1	15,0	64,5	2,5	47,5	1	77,40
	555602	142-2	23,5	65,0	3,0	48,0	1	79,80
	555619	142-3	15,0	46,0	2,5	29,0	1	79,80
	555626	142-4	26,5	30,0	5,0	16,0	1	79,80



140-3

### 143 MULTI-LOCK Zahnrad-Blockiervorrichtung

Sprocket MULTI-LOCK Timing Device  
 Bloque-arbres à cames MULTI-LOCK  
 Dispositivo de bloqueo de engranajes MULTI-LOCK  
 MULTI-LOCK tandwiel-blokkeerapparaat



	<b>EAN-Code</b> 4021176-974519	<b>Art.-No.</b> 143		<b>Euro</b> 185,40
--	-----------------------------------	------------------------	--	-----------------------

### 144 Gegenhalter für Speichenräder

Sprocket-Holding Tool  
 Bloque-roues à rayons  
 Contraapoyo para ruedas de radios  
 Tegenhouder voor spaaktandwielen



	<b>EAN-Code</b> 4021176-974519	<b>Art.-No.</b> 144		<b>Euro</b> 75,10
--	-----------------------------------	------------------------	--	----------------------

### KS-155 Entriegelungswerkzeugsatz

Unlocking tool set

**NEU-NEW**

zum zerstörungsfreien Lösen und Ausbauen von Steckkontakten an der Fahrzeugelektronik



für / for / pour  
 PKW / LKW / NFZ



	<b>EAN-Code</b>	<b>Art.-No.</b>	<b>Inhalt</b> contents / contenu / inhoud		<b>Euro</b>
	111181	<b>KS-155-1/5</b>	5-teilig / parts PKW	1	247,90
	800252	<b>KS-155-1/12</b>	12-teilig / parts PKW	1	810,70
	111525	<b>KS-155-1/6</b>	6-teilig / parts LKW	1	312,30
	800269	<b>KS-155-1/17</b>	17-teilig / parts LKW	1	1068,30

### TIPP: KS-155...

Jedem Entriegelungswerkzeug-Satz liegt eine detaillierte Bedienungsanleitung mit Anwendungsinformationen bei. Diese steht auch im Internet unter:  
[www.KUKKO.com/download/pdf/entriegelungswerkzeug.pdf](http://www.KUKKO.com/download/pdf/entriegelungswerkzeug.pdf)  
 als Download zur Verfügung oder kann als Broschüre (BA-155) einzeln bestellt werden.



### 160 Flanschentreiber

Flange spreaders  
 Chasse-bridés  
 Separadores de bridas  
 Flenzenspreider



	<b>EAN-Code</b> 4021176-025273	<b>Art.-No.</b> 160-1		80- 250		1 Paar / Pair / Paire	<b>Euro</b> 451,10
	-025358	160-2		250-1200		1 Paar / Pair / Paire	834,60

### 165 Universal Spreizer 20KN (2 to)

Universal spreader  
 Écarteur universel  
 Extensor universal  
 Universele spreider



	<b>EAN-Code</b> 4021176-491979	<b>Art.-No.</b> 165-E		10 - 75		1	<b>Euro</b> 1158,70
--	-----------------------------------	--------------------------	--	---------	--	---	------------------------

### 200-U Farm- und Werkstattabzieher

Farm and shop puller  
 Extracteur pour la ferme et l'atelier  
 Extractor para granjas y talleres  
 Landbouw- en werkplaatstrekker

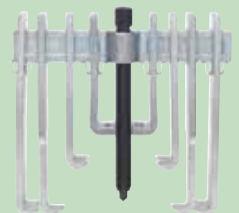

	<b>EAN-Code</b> 4021176-025433	<b>Art.-No.</b> 200-U		250		80-180		1	<b>Euro</b> 179,50
--	-----------------------------------	--------------------------	--	-----	--	--------	--	---	-----------------------

### 200-UM Abzieher 200-U im Metallkasten

Puller 200-U in metal case  
 Extracteur 200-U en coffret  
 Extractor 200-U en caja metálica  
 Trekker 200-U in metalen kist



	<b>EAN-Code</b> 4021176-025501	<b>Art.-No.</b> 200-UM	<b>Inhalt</b> contents/contenu/inhoud	200-U		1	<b>Euro</b> 228,80
--	-----------------------------------	---------------------------	--	-------	--	---	-----------------------

# INFO-BOX

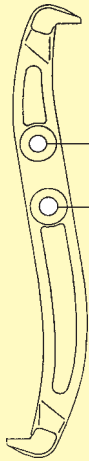

**2** = Anzahl der Löcher  
number of holes

## 201-S 202-S Abzieher für Lüfterräder

Pullers for fan wheels  
Extracteurs de rotors de ventilateurs  
Extractores para rodetes de ventilador  
Trekkers voor ventilatorbladen

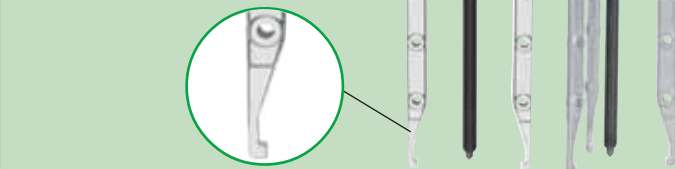

32	EAN-Code	Art.-No.	mm	mm			Euro
ST	4021176-026911	201-S	200	200	③	1	87,80
	-027581	202-S	200	200	③	1	117,10

## 201 2-armige Abzieher

2-arm pullers  
Extracteurs à 2 bras  
Extractores de 2 brazos  
2-armige trekkers

mit umkehrbaren Abzughaken  
with reversible double-end jaws  
à griffes réversibles  
con garras reversibles  
met omkeerbare trekhaken



32	EAN-Code	Art.-No.	mm	mm			Euro
ST	4021176-026423	201-0	100	75	①	1	43,60
	-026591	201-1	150	85	①	1	57,10
	-026676	201-2	220	130	①	1	97,60
	-026751	201-3	300	260	②	1	191,00
	-026836	201-4	380	300	②	1	215,90

## 202 3-armige Abzieher

3-arm pullers  
Extracteurs à 3 bras  
Extractores de 3 brazos  
3-armige trekkers

mit umkehrbaren Abzughaken  
with reversible double-end jaws  
à griffes réversibles  
con garras reversibles  
met omkeerbare trekhaken



32	EAN-Code	Art.-No.	mm	mm			Euro
ST	4021176-027093	202-0	100	75	①	1	59,00
	-027178	202-1	150	85	①	1	74,20
	-027253	202-2	220	130	①	1	127,80
	-027338	202-3	300	260	②	1	253,80
	-027413	202-4	380	300	②	1	290,40

## 203 3-armige Kombi-Abzieher

3-arm combination pullers  
Extracteurs combinés à 3 bras  
Extractores combinados de 3 brazos  
3-armige combi-trekkers

mit umkehrbaren Abzughaken  
with reversible double-end jaws  
à griffes réversibles  
con garras reversibles  
met omkeerbare trekhaken

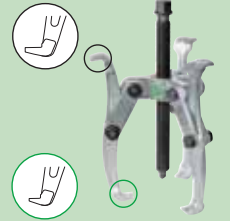

32	EAN-Code	Art.-No.	mm	mm			Euro
ST	4021176-027666	203-0	120	75	①	1	61,60
	-027741	203-1	180	85	①	1	78,60
	-027826	203-2	280	130	①	1	133,90
	-027901	203-3	350	260	②	1	296,20
	-028083	203-4	400	300	②	1	332,70

## K-203

### 2- und 3-armige Abzieher-Satz

Set of 2- and 3-arm Pullers  
Jeu de extracteurs à 2- et à 3-bras  
Juego de extractores de 2 y de 3 brazos  
2- en 3-armige trekkers-set

mit umkehrbaren Abzughaken  
with reversible double-end jaws  
à griffes d'extraction réversibles  
con garras reversibles  
met omkeerbare trekhaken



34	EAN-Code	Art.-No.	Satz/Set/Jeu		Euro
ST	4021176-280351	K-203		1	307,50

## K-20315

### 2- und 3-armige Abzieher mit Trennvorrichtung

Set of two- and three-arm pullers with separator  
Jeu d'extracteurs à 2- et 3 bras avec décolleur  
Extractores de 2 y de 3 brazos y separador  
Twee- en drie-armige trekkers met mestrekker-set

mit umkehrbaren Abzughaken  
with reversible double-end jaws  
à griffes d'extraction réversibles  
con garras reversibles  
met omkeerbare trekhaken



34	EAN-Code	Art.-No.	Satz/Set/Jeu		Euro
ST	4021176-280504	K-20315		1	497,50

## P-203 Display-Pack

### 2- und 3-armige Abzieher-Satz

Set of 2- and 3-arm Pullers  
Jeu de extracteurs à 2- et à 3-bras  
Juego de extractores de 2 y de 3 brazos  
2- en 3-armige trekkers-set

mit umkehrbaren Abzughaken  
with reversible double-end jaws  
à griffes d'extraction réversibles  
con garras reversibles  
met omkeerbare trekhaken



34	EAN-Code	Art.-No.	Satz/Set/Jeu		Euro
ST	4021176-280764	P-203		1	245,60

## P-20315 Display-Pack

### 2- und 3-armige Abzieher mit Trennvorrichtung

Set of two- and three-arm pullers with separator  
Jeu d'extracteurs à 2- et 3 bras avec décolleur  
Extractores de 2 y de 3 brazos y separador  
Twee- en drie-armige trekkers met mestrekker-set

mit umkehrbaren Abzughaken  
with reversible double-end jaws  
à griffes d'extraction réversibles  
con garras reversibles  
met omkeerbare trekhaken



34	EAN-Code	Art.-No.	Satz/Set/Jeu		Euro
ST	4021176-280924	P-20315		1	435,80





### 204-0 Lagerabzieher „COBRA“

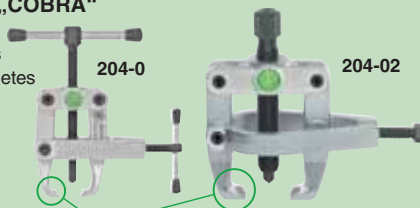

 Bearing pullers  
 Arrache-roulements  
 Extractores de cojinetes  
 Lagertrekkers





mit **Trennkralle** und seitlicher Spannzwinde  
 with **separating claw** and side clamp  
 avec étrier de serrage latéral  
 con tornillo lateral de apriete  
 met zijdelingse spanbeugel

25	EAN-Code	Art.-No.	 mm	 mm		Euro
ST	4021176-					
	-028168	204-0	50	70	1	96,00
	-339516	204-02	90	100	1	148,40

### 204 Abzieher mit seitlicher Spannzwinde „COBRA“



 Pullers with side clamp  
 Extracteurs avec étrier de serrage latéral  
 Extractores con tornillo lateral de apriete  
 Trekkers met zijdelingse spanbeugel



25	EAN-Code	Art.-No.	 mm	 mm		Euro
ST	4021176-					
	-028243	204-1	80	90	1	108,30
	-028328	204-2	100	100	1	123,60
	-028403	204-3	150	140	1	201,00

### 204-30 Abzieher für Steller an Bremsgestängen

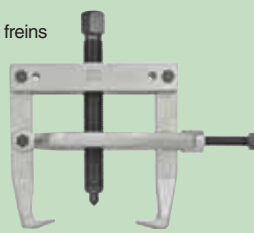
Pullers for brake linkage adjusters  
 Extracteur pour organe de réglage sur tringleries de freins  
 Extractores para reguladores en varillajes de frenos  
 Trekkers voor remsteller van remsystemen



an LKW-Anhängern  
 on truck trailers  
 de remorques de camions  
 en remolques de camiones  
 van vrachtwagenaanhangers



	EAN-Code	Art.-No.	an/on/sur Achsen/Axles/Essieux		Euro
	-914195	204-30	universal	1	224,00

### 204-44 Universal-Lenkstockhebelabzieher



 Universal drop arm puller  
 Arrache-biellettes pendantes de direction  
 Extractor de brazos de mando universal  
 Universele stuurstangtrekker  
 Estrattore universale per braccio comando sterzo

für mittlere und schwere Nutzfahrzeuge  
 for commercial vehicles, buses, coaches  
 pour camions  
 para camiones  
 voor vrachtwagens  
 per auticarri



	EAN-Code	Art.-No.	 mm (")	 mm (")		Euro
ST	4021176-					
	-002168	204-44	90 (3.5/8")	70 (2.3/4")	1	89,60

### 204-V Abzieher für Lagerinnenring

 Puller for inner races  
 Arrache-bagues intérieurs de roulement  
 Extractor para el anillo interior del cojinete en el  
 Trekker voor lagerbinnenringen aan de voorste  
 an der vorderen Radnabe VW/AUDI  
 of front wheel hubs VW/AUDI  
 du moyeu avant sur véhicules VW et Audi  
 cubo de rueda delantero en automóviles VW/AUDI  
 wielnaaf van VW/AUDI wagens







69	EAN-Code	Art.-No.	an/on/sur Radlagern/ wheel bearings/roulements de roue		Euro
ST	4021176-				
	-974533	204-V	V 10.1 (Volkswagen)	1	137,00

### 205 2-armige Abzieher



 2-arm pullers  
 Extracteurs à 2 bras  
 Extractores de 2 brazos  
 2-armige trekkers

mit verstellbarer Spanntiefe  
 with adjustable reach  
 à profondeur réglable  
 con profundidad regulable  
 met verstelbare spandiepte



33	EAN-Code	Art.-No.	 mm	 mm			Euro
ST	4021176-						
	-028571	205-00	100	100	②	1	39,40
	-028656	205-01	150	150	②	1	54,70
	-028731	205-02	250	220	②	1	90,70
	-028816	205-1	300	280	②	1	151,10
	-028991	205-2	400	400	③	1	185,80
	-029073	205-3	500	540	③	1	212,60
	-880056	205-65	650	650	①	1	562,00
	-880063	205-80	800	800	①	1	616,30
	-880049	205-95	1000	1000	①	1	671,10





### 205-B 2-armige Abzieher

 2-arm pullers  
 Extracteurs à 2 bras  
 Extractores de 2 brazos  
 2-armige trekkers

mit verstellbarer Spanntiefe  
 with adjustable reach  
 à profondeur réglable  
 con profundidad regulable  
 met verstelbare spandiepte

**7 + 10 + 12 to**  
**hydraulic**  
 TECHNOLOGY







33	EAN-Code	Art.-No.	 mm	 mm		to/KN	mit with/avec		Euro
ST	4021176-								
	-886072	205-02-B	250	220	②	7/ 70	8-01	1	284,40
	-886089	205-1-B	300	280	②	10/100	8-02	1	354,60
	-886096	205-2-B	400	400	③	10/100	8-02	1	384,70
	-886102	205-3-B	500	540	③	12/120	8-02	1	411,50

### 206 3-armige Abzieher



 3-arm pullers  
 Extracteurs à 3 bras  
 Extractores de 3 brazos  
 3-armige trekkers

mit verstellbarer Spanntiefe  
 with adjustable reach  
 à profondeur réglable  
 con profundidad regulable  
 met verstelbare spandiepte



33	EAN-Code	Art.-No.	 mm	 mm			Euro
ST	4021176-						
	-029158	206-00	100	100	②	1	52,80
	-029233	206-01	150	150	②	1	70,20
	-029318	206-02	250	220	②	1	117,60
	-029493	206-1	300	280	②	1	193,60
	-029561	206-2	400	400	③	1	243,90
	-029646	206-3	500	540	③	1	283,90





### 206-B 3-armige Abzieher

 3-arm pullers  
 Extracteurs à 3 bras  
 Extractores de 3 brazos  
 3-armige trekkers

mit verstellbarer Spanntiefe  
 with adjustable reach  
 à profondeur réglable  
 con profundidad regulable  
 met verstelbare spandiepte

**7 + 10 + 12 to**  
**hydraulic**  
 TECHNOLOGY



33	EAN-Code	Art.-No.	 mm	 mm		to/KN	mit with/avec		Euro
ST	4021176-								
	-886119	206-02-B	250	220	②	7/ 70	8-01	1	311,20
	-412448	206-1-B	300	280	②	10/100	8-02	1	412,30
	-886126	206-2-B	400	400	③	10/100	8-02	1	460,30
	-886133	206-3-B	500	540	③	12/120	8-02	1	497,50



### 207 3-armige Kombi-Abzieher

3-arm combination pullers  
 Extracteurs combinés à 3 bras  
 Extractores combinados de 3 brazos  
 3-armige combi-trekkers

mit verstellbarer Spanntiefe  
 with adjustable reach  
 à profondeur réglable  
 con profundidad regulable  
 met verstelbare spandiepte



33	EAN-Code	Art.-No.	mm	mm			Euro
ST	4021176-						
	-029721	207-00	120	100	②	1	55,40
	-029806	207-01	200	150	②	1	74,60
	-029981	207-02	300	220	②	1	123,90
	-030048	207-1	400	280	②	1	235,80
	-030123	207-2	450	400	③	1	286,00
	-030208	207-3	550	540	③	1	326,30
	-880100	207-65	650	650	①	1	718,60
	-880117	207-80	800	800	①	1	799,80
	-880094	207-95	1000	1000	①	1	881,50

### K-207

#### 2- und 3-armige Abzieher-Satz

Set of two- and three-arm pullers  
 Jeu d'extracteurs à 2- et 3 bras  
 Juego de extractores de 2 y de 3 brazos  
 Twee- en drie-armige trekkers-set

mit verstellbarer Spanntiefe  
 with adjustable reach  
 à profondeur réglable  
 con profundidad regulable  
 met verstelbare spandiepte



ST	EAN-Code	Art.-No.	Satz/Set/Jeu	Euro
	4021176-	K-207		
	-280436		1	286,70

### K-20715 2- und 3-armige Abzieher mit Trennvorrichtung-Satz

Set of two- and three-arm pullers with separator  
 Jeu d'extracteurs à 2- et 3 bras avec décolleur  
 Juego de extractores de 2 y de 3 brazos con separador  
 Twee- en drie-armige trekkers met mestrekker-set

mit verstellbarer Spanntiefe  
 with adjustable reach  
 à profondeur réglable  
 con profundidad regulable  
 met verstelbare spandiepte



ST	EAN-Code	Art.-No.	Satz/Set/Jeu	Euro
	4021176-	K-20715		
	-280689		1	461,80

### P-207 Display-Pack

#### 2- und 3-armige Abzieher-Satz

Set of two- and three-arm pullers  
 Jeu d'extracteurs à 2- et 3 bras  
 Juego de extractores de 2 y de 3 brazos  
 Twee- en drie-armige trekkers-set

mit verstellbarer Spanntiefe  
 with adjustable reach  
 à profondeur réglable  
 con profundidad regulable  
 met verstelbare spandiepte



ST	EAN-Code	Art.-No.	Satz/Set/Jeu	Euro
	4021176-	P-207		
	-280849		1	216,40

### P-20715 Display-Pack

#### 2- und 3-armige Abzieher mit Trennvorrichtung-Satz

Set of two- and three-arm pullers with separator  
 Jeu d'extracteurs à 2- et 3 bras avec décolleur  
 Juego de extractores de 2 y de 3 brazos con separador  
 Twee- en drie-armige trekkers met mestrekker-set

mit verstellbarer Spanntiefe  
 with adjustable reach  
 à profondeur réglable  
 con profundidad regulable  
 met verstelbare spandiepte



ST	EAN-Code	Art.-No.	Satz/Set/Jeu	Euro
	4021176-	P-20715		
	-281006		1	408,80

### 207-B 3-armige Kombi-Abzieher

3-arm combination pullers  
 Extracteurs combinés à 3 bras  
 Extractores combinados de 3 brazos  
 3-armige combi-trekkers

mit verstellbarer Spanntiefe  
 with adjustable reach  
 à profondeur réglable  
 con profundidad regulable  
 met verstelbare spandiepte

7 + 10 + 12 to  
**hydraulic**  
 TECHNOLOGY



ST	EAN-Code	Art.-No.	mm	mm	to/KN	mit with/avec	Euro
	4021176-						
	-886140	207-02-B	300	170	②	7/70 8-01	1 317,50
	-886157	207-1-B	400	230	②	10/100 8-02	1 439,20
	-886164	207-2-B	450	350	③	10/100 8-02	1 485,10
	-886171	207-3-B	550	490	③	12/120 8-02	1 525,10

### 208/209-0 Abzieher

Pullers  
 Extracteurs  
 Extractores  
 Trekkers

mit umkehrbaren Abzughaken  
 with reversible double-end jaws  
 à griffes réversibles  
 con garras reversibles  
 met omkeerbare trekhaken

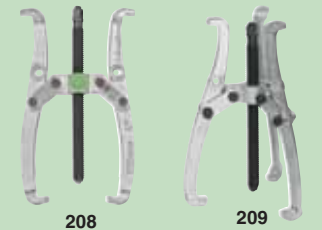

57	EAN-Code	Art.-No.	mm	mm		Euro
ST	4021176-					
	-432248	208-0	100	50-75-100	②	1 32,70
	-432323	209-0	100	50-75-100	②	1 43,60

### 208/209 Abzieher

Pullers  
 Extracteurs  
 Extractores  
 Trekkers

208-01  
 208-02

209-01  
 209-02

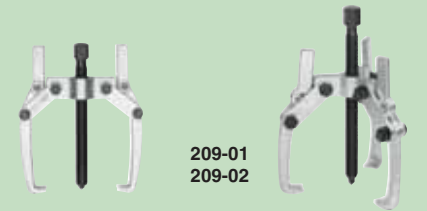

57	EAN-Code	Art.-No.	mm	mm		Euro
ST	4021176-					
	-432408	208-01	20-170	95-125	②	1 53,60
	-432651	208-02	20-230	150-190	②	1 87,20
	-432576	209-01	20-170	95-125	②	1 74,30
	-432736	209-02	20-230	150-190	②	1 112,20

### 209-2-B 3-armiger Abzieher

3-arm puller  
 Extracteur à 3 bras  
 Extractor de 3 brazos  
 3-armige trekker

mit hydraulischer Spindel  
 with hydraulic screw  
 avec vis hydraulique  
 con husillo hidráulico  
 met hydraulische spindel

15 to  
**hydraulic**  
 TECHNOLOGY

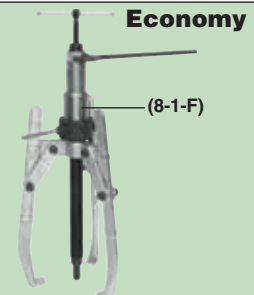

57	EAN-Code	Art.-No.	mm	mm		Euro
ST	4021176-					
	-432996	209-2-B	500	225-300-400	③	1 709,20

### 210 Trennabzieher „COBRA“

Separator pullers  
 Extracteur-décolleur  
 Separadores-Extractores  
 Scheidende trekkers

mit Trennkrallen und seitlicher Spannzwinde  
 with separating claw and side clamp  
 avec étrier de serrage latéral  
 con tornillo lateral de apriete  
 met zijdelingse spanbeugel





25	EAN-Code	Art.-No.	mm	mm		Euro
ST	4021176-					
	-030383	210-1	95	170	④	1 181,50
	-030468	210-2	135	270	⑤	1 226,00
	-030536	210-3	150	325	⑤	1 259,10



### 220 Universalabzieher mit Gleithammer

Universal puller with slide hammer  
 Extracteur universel à masse coulissante  
 Extractor universal con martillo de correa  
 Universele trekker met glijhamer



36 ST	<b>EAN-Code</b>	<b>Art.-No.</b>	 mm	 mm		<b>Euro</b>
	4021176-030611	220	0 - 130	80 - 200	1	401,90

### 220-T Universal Abziehsatz auf Lochplatte



Universal pulling set on wall panel  
 Jeu d'extracteurs universels sur panneau  
 Juego de extractores universales en panel mural  
 Unversele trekkers - set op wandbord





*Schlagabzieher  
 Percussion Type  
 Modèles à frapper  
 Tipo de percusión  
 Slagtrekkers*

37 ST	<b>EAN-Code</b>	<b>Art.-No.</b>	<b>Satz/Set/Jeux</b>		<b>Euro</b>
	4021176-778759	220-T	auf Wandtafel	1	937,20
	-874055	220-K	im Kasten/in case/dans boîte	1	937,20

### 220 Abzieher mit konischer Selbstspannung

 Pullers with cone-driven spread adjuster  
 Extracteurs à guidage conique  
 Extractores con ajuste del alcance guiado por cono  
 Trekkers met conus-geleide spanwijdte-instelling



36 ST	<b>EAN-Code</b>	<b>Art.-No.</b>	 mm	 mm		<b>Euro</b>
	4021176-778919	220-02	200	165	1	186,80
	-779091	220-03	200	165	1	217,00

### 221-G Innenauszieher mit Gleithammer

Internal extractor with slide hammer  
 Extracteur intérieur à masse coulissante  
 Extractor interior con martillo de correa  
 Binnentrekker met glijhamer



42 ST	<b>EAN-Code</b>	<b>Art.-No.</b>	<b>Ø</b> mm	<b>L</b> mm		<b>Euro</b>
	4021176-175824	221-G	30 - 180	140	1	292,70

### 223 Abzieher für Teile mit Gewindelöchern

Extractor for parts with tapholes  
 Extracteur pour pièces à trous taraudés  
 Extractor para piezas con agujeros roscados  
 Trekker voor delen met schroefdraadgaten

### 223-K Passfeder- und Passstiftauszieher Satz

Set of parallel-key and dowel-pin extractors  
 Jeu d'arrache-clavettes et arrache-pions de centrage  
 Juego de extractores de chavetas y pasadores de ajuste  
 Pasveer- en paspentrekker- set

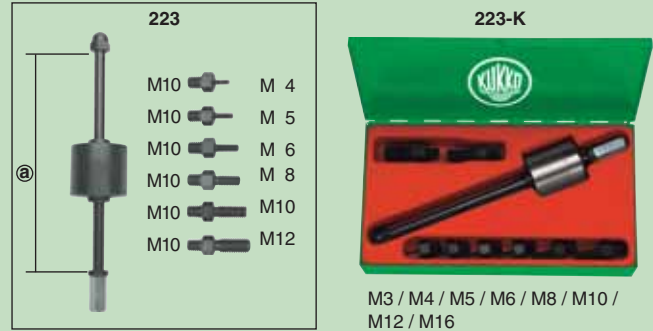

43 ST	<b>EAN-Code</b>	<b>Art.-No.</b>		<b>Euro</b>
	4021176-309083	223	M4 / M5 / M6 / M8/ M10 / M12	1 75,80
	-784859	223-K	M3 / M4 / M5 / M6 / M8/ M10 / M12 / M16	1 142,60
44	-309168	223-GH	@ Zubehör/Accessories	1 28,30

### 224 Innenauszieher mit Gleithammer

Internal extractors with slide hammer  
 Extracteurs intérieures à masse coulissante  
 Extractores interiores con martillo de correa  
 Binnentrekkers met glijhamer

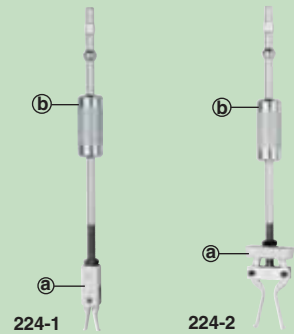

42 ST	<b>EAN-Code</b>	<b>Art.-No.</b>	<b>Ø</b> mm		<b>Euro</b>
	-325656	224-1	12 - 35	1	159,10
	-325571	224-2	15 - 50	1	149,00
	-325731	224-121	@ Zubehör/Accessories	1	81,00
	-325816	224-221	@ Zubehör/Accessories	1	103,40
	-325403	224-GH	b) Zubehör/Accessories	1	45,90

### 224 Auszieher für Einspritzdüse „ACTROS“

Extractor for injection nozzle „ACTROS“



42 ST	<b>EAN-Code</b>	<b>Art.-No.</b>	<b>ACTROS</b>		<b>Euro</b>
	4021176-902918	224-GHM		1	77,80





### 225 Staubkappen Ein- und Auszieher

Dust-cap installer and remover  
 Dispositif de pose et de dépose de capuchons antipoussières  
 Instalador y desinstalador de tapones contra el polvo  
 Stofkap in- en uittrekgereedschap  
 Estrattore per coperchio di protezione dalla polvere della ruota



EAN-Code	Art.-No.	mm		Euro
4021176-924132	225-DC	65	1	384,40



### 229 Radnabenabzieher

Wheel puller  
 Extracteur moyeu  
 Extractor il morro

**10 + 15 to**  
**hydraulic**  
TECHNOLOGY



229-100

für fast alle 4- und 5-Loch-Naben  
 suitable for almost all 4- and 5-hole hubs

EAN-Code	Art.-No.	kompatibel mit compatible with	to		Euro
4021176-995026	229-2	229-1	10	1	304,40
-995033	229-3	229-1	15	1	405,80
-117336	229-03	für/for/pour 229-2; 229-3		1	160,00
-995019	229-100	Adapter für/for/pour 229-11	40,00		

### 230 Steckachsenabzieher

Flange type axle puller  
 Extracteur de demi-arbres  
 Extractor de semiejes  
 Steekas-slagtrekker



230

Abzieher für Teile mit Gewindelöchern  
 Puller for parts with tapholes  
 Extracteur pour pièces à trous taraudés  
 Extractor para piezas con agujeros roscados  
 Trekker voor delen met schroefdraadgaten



EAN-Code	Art.-No.	Ø-mm	Teilkreise P.C.D. / Cercles de perçage		Euro
4021176-031038	230	4 - 14	Ø 100 - 150	1	167,40
-893377	230-S	4 - 14	Ø 100 - 150	1	91,10

### 229 Universal-Gleithammer

Universal slide hammer devices  
 Dispositifs à masse coulissante universel  
 Martillos de correa universale  
 Glijhamer- gereedschap Universeel

**NEU-NEW**

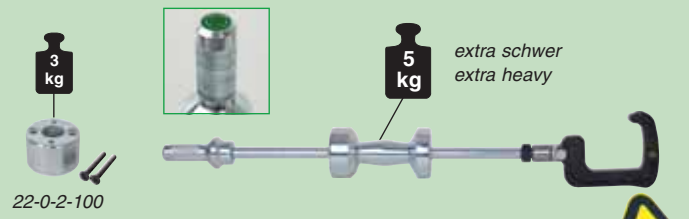

EAN-Code	Art.-No.		Euro
4021176-995002	229-1	22-0-2 + 229-01	332,00
-117329	229-1-2	22-0-2 + 229-03	532,00
-117329	229-01	Haken/claw	80,00
-111211	22-0-2-100	Zusatzgewicht / additional weight	40,00

### 230-I Ausschlagwerkzeug für Injektoren



an Mercedes CDI Dieselmotoren

EAN-Code	Art.-No.		Euro
4021176-977626	230-I	MB CDI	200,00

### 243 Universal-Abzieher mit Schlaghammer

Universal jaw puller with slide hammer  
 Extracteur universel à masse coulissante  
 Extractor universal con martillo de correa  
 Universele slagtrekker  
 Estrattore universale a percussione

selbstzentrierend  
 self centering  
 autocentreuse  
 autocentrantes  
 zelfcenterend

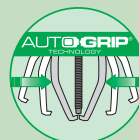

EAN-Code	Art.-No.	mm	mm	Euro
4021176-924170	243-12	70	70	112,00

**TIPP: 22-0-2 + 229-03**



22-0-2 + 229-03 = 229-1-2



### 482 2-armige Abzieher

2-arm pullers  
 Extracteurs à 2 bras  
 Extractores de 2 brazos  
 2-armige trekkers





24	EAN-Code	Art.-No.	 mm	 mm		Euro
ST	4021176-479779	482-1	60	40	1	36,00
	-479854	482-2	85	90	1	37,20
	-479939	482-3	150	150	1	105,10
	-480096	482-4	200	200	1	123,60
	-480171	482-5	250	250	1	127,40

### 483 3-armige Abzieher

3-arm pullers  
 Extracteurs à 3 bras  
 Extractores de 3 brazos  
 3-armige trekkers



24	EAN-Code	Art.-No.	 mm	 mm		Euro
ST	4021176-480331	483-2	85	90	1	48,40
	-480416	483-3	150	150	1	124,30
	-480584	483-4	200	200	1	144,80
	-480669	483-5	250	250	1	169,90

### 482-DP 2-armige Autogrip Abzieher

2-arm Autogrip pullers  
 Extracteurs Autogrip à 2 bras  
 Extractores Autogrip de 2 brazos  
 2-armige Autogrip trekkers

im Display  
 in display package  
 en display  
 en envase de display  
 in display-karton



24	EAN-Code	Art.-No.	Inhalt		Euro
ST	4021176-745836	482-DP	contents/contenu/inhoud 482-1, 482-2, 482-3	1	198,20



### 482/483 2- und 3-armige Abzieher-Sätze in Rolltasche

2- and 3-arm puller sets  
 Jeu d'extracteurs à 2 et 3 bras  
 Juego de extractores de 2 y 3 brazos  
 2- en 3-armige trekkers-set

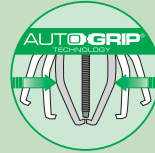
NEU · NEW



482-1-2-3-T = 3-teilig/parts  
 482/483-2-T = 2-teilig/parts  
 482/483-3-T = 2-teilig/parts

24	EAN-Code	Art.-No.	Inhalt	 mm	 mm		Euro
ST	-500008	482-1-2-3-T	482-1; 482-2; 482-3	0-150	0-150	1	208,70
	-500015	482/483-2-T	482-2; 483-2	0- 85	0- 90	1	106,20
	-500022	482/483-3-T	482-3; 483-3	0-150	0-150	1	320,70

## DEMO-Wagen



TRENN-Abziehen



INNEN-Abziehen



## INFO-Box

**6 xx xxx Druckspindeln**  
 Pressure screws  
 Vis de pression  
 Husillos de presión  
 Drukspindels

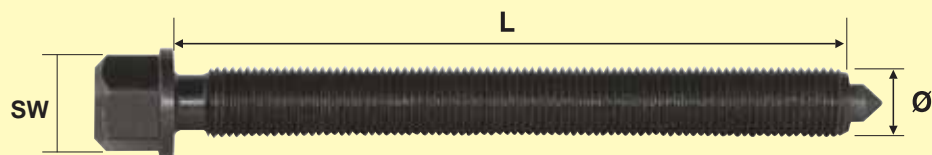

**Art.-No. 6 14 160**

Druckspindel      Ø      L  
 Pressure screw      mm      mm

	EAN-Code 4021176-	Art.-No.	passend zu suitable for / s'adaptant à / geschikt voor	SW mm	Gewinde threads/ filets		PG
M 8	-176241	<b>608080-PG1</b>	48, 482-1	—	<b>M 8</b>	1	1
	-481086	<b>608130-PG1</b>	482-2, 483-2	—	<b>M 8</b>	1	1
M 9	-102493	<b>609087-PG1</b>	41-1, 42-1, 43-1, 43-11, 43-12, 43-2	—	<b>M 9</b>	1	1
	-101403	<b>609105-PG1</b>	41-2, 42-2, 43-3, 43-13	—	<b>M 9</b>	1	1
M 10	-362446	<b>610070-PG1</b>	41-0, 42-0	<b>13</b>	<b>M 10</b>	1	1
	-122118	<b>610094-PG2</b>	204-0	—	<b>M 10</b>	1	2
	-433726	<b>610110-PG1</b>	208-0, 209-0, 112-1, 112-10	<b>8</b>	<b>M 10</b>	1	1
M 12x1,5	-238468	<b>612080-PG3</b>	201-0, 202-0, 203-0	<b>14</b>	<b>M 12x1,5</b>	1	3
	-112881	<b>612110-PG3</b>	205-00, 206-00, 207-00	<b>13</b>	<b>M 12x1,5</b>	1	3
	-077081	<b>612130-PG2</b>	18-0, 44-1, 45-1	<b>13</b>	<b>M 12x1,5</b>	1	2
	-425073	<b>612131-PG2</b>	14-01, 14-1	<b>13</b>	<b>M 12x1,5</b>	1	2
	-790201	<b>612150-PG2</b>	41-3, 42-3	<b>13</b>	<b>M 12x1,5</b>	1	2
M 12	-480744	<b>612200-PG2</b>	482-3, 483-3	<b>10</b>	<b>M 12</b>	1	2
M 14x1,5	-074271	<b>614135-PG2</b>	12-1, 30-1, 30-1+, 30-1-2, 30-10, 30-10+, 30-10-2, 32-1, 33, 112-2, 201-1, 202-1, 203-1	<b>17</b>	<b>M 14x1,5</b>	1	2
	-466076	<b>614137-PG2</b>	30-1-S, 30-1+S, 30-10-S, 30-10+S, 30-10SP, 200-1, 200-2, 301-2	<b>13</b>	<b>M 14x1,5</b>	1	2
	-112966	<b>614160-PG2</b>	20-1, 20-10, 44-2, 45-2, 112-20, 113-20, 205-01, 206-01, 207-01, 208-01, 209-01	<b>17</b>	<b>M 14x1,5</b>	1	2
	-990281	<b>614161-PG2</b>	20-1-S, 20-10-S, 20-1+S, 20-10+S	<b>13</b>	<b>M 14x1,5</b>	1	2
	-838576	<b>614200-PG3</b>	41-4, 42-4	<b>17</b>	<b>M 14x1,5</b>	1	3
	-208188	<b>614240-PG2</b>	70-2, 201-S, 202-S	<b>17</b>	<b>M 14x1,5</b>	1	2
-306709	<b>614250-PG2</b>		<b>17</b>	<b>M 14x1,5</b>	1	2	
M 16	-284236	<b>616160-PG2</b>	14-2	<b>17</b>	<b>M 16</b>	1	2
	-264351	<b>616202-PG2</b>	14-3, 14-03	<b>19</b>	<b>M 16</b>	1	2
	-480829	<b>616270-PG2</b>	482-4, 483-4	<b>13</b>	<b>M 16</b>	1	2
	-480904	<b>616325-PG3</b>	482-5, 483-5	<b>13</b>	<b>M 16</b>	1	3
M 16x1,5	-420856	<b>616220-PG2</b>	112-3, 113-3	<b>17</b>	<b>M 16x1,5</b>	1	2
M 18x1,5	-966866	<b>618104-PG2</b>	17-2	<b>19</b>	<b>M 18x1,5</b>	1	2
	-073779	<b>618105-PG2</b>	204-1	<b>19</b>	<b>M 18x1,5</b>	1	2
	-074356	<b>618175-PG2</b>	12-2, 18-1, 32-2	<b>19</b>	<b>M 18x1,5</b>	1	2
	-113048	<b>618210-PG2</b>	44-3, 45-3	<b>19</b>	<b>M 18x1,5</b>	1	2
M 20	-816040	<b>620162-PG4</b>	28-1	<b>24</b>	<b>M 20</b>	1	4
	-817946	<b>620172-PG5</b>	28-2	<b>24</b>	<b>M 20</b>	1	5
	-818028	<b>620230-PG5</b>	28-3	<b>24</b>	<b>M 20</b>	1	5
	-818103	<b>620250-PG5</b>	28-4	<b>24</b>	<b>M 20</b>	1	5
	G 1/2"	-124358	<b>621130-PG2</b>	204-2, 204-02	<b>22</b>	<b>G 1/2"</b>	1
-966880		<b>621169-PG2</b>	17-3	<b>22</b>	<b>G 1/2"</b>	1	2
-067181		<b>621170-PG2</b>	18-2	<b>22</b>	<b>G 1/2"</b>	1	2
-078569		<b>621210-PG2</b>	20-20-3, 20-20+3, 30-2, 30-2+, 30-2-3, 30-20, 30-20+, 30-20-3, 31-1, 31-2	<b>17</b>	<b>G 1/2"</b>	1	2
			200-3, 200-4, 200-41, 200-5, 200-51, 200-U, 201-2, 202-2, 203-2, 205-02, 206-02, 207-02, 208-02, 209-02, 210-1, 210-01, 301-3, 301-4				
-703263		<b>621211-PG2</b>	20-2-S, 20-2+S, 20-20-S, 20-20+S, 20-20SP, 30-2-S, 30-2+S, 30-20-S, 30-20+S, 30-20SP	<b>22</b>	<b>G 1/2"</b>	1	2
-818028		<b>621220-PG2</b>	20-2, 20-20, 20-2+, 20-20+, 20-2-S, 20-20-S, 30-2, 30-20, 30-2+, 30-20+, 30-2-S, 30-20-S	<b>22</b>	<b>G 1/2"</b>	1	2
-838323		<b>621245-PG2</b>	41-5, 42-5	<b>22</b>	<b>G 1/2"</b>	1	2
-236228		<b>621355-PG4</b>	70-4, 112-4, 113-4	<b>24</b>	<b>G 1/2"</b>	1	4
G 5/8"	-124501	<b>623170-PG4</b>	204-3	<b>24</b>	<b>G 5/8"</b>	1	4
	-074684	<b>623230-PG5</b>	12-3	<b>24</b>	<b>G 5/8"</b>	1	5
	-113123	<b>623260-PG5</b>	44-4, 45-4	<b>24</b>	<b>G 5/8"</b>	1	5
	-125263	<b>623325-PG5</b>	44-5, 45-5, 113-5, 210-2, 210-3	<b>24</b>	<b>G 5/8"</b>	1	5
	-814976	<b>623360-PG6</b>	44-6, 45-6	<b>24</b>	<b>G 5/8"</b>	1	6
	-832796	<b>623450-PG7</b>	45-7	<b>24</b>	<b>G 5/8"</b>	1	7
G 3/4"	-076749	<b>626280-PG4</b>	18-3, 20-3, 20-3+, 20-3-3, 20-3-4, 20-3-5, 20-30, 20-30+, 20-30-3, 20-30-4, 20-30-5, 30-3	<b>27</b>	<b>G 3/4"</b>	1	4
			30-3+, 30-3-3, 30-3-4, 30-3-5, 201-3, 201-4, 202-3, 202-4, 203-3, 203-4, 205-1, 206-1, 207-1				
	-703423	<b>626281-PG4</b>	20-3-S, 20-3+S, 20-30-S, 20-30+S, 20-30SP, 30-3-S, 30-3+S, 30-3SP	<b>19</b>	<b>G 3/4"</b>	1	4
	-813498	<b>626355-PG5</b>	12-4	<b>27</b>	<b>G 3/4"</b>	1	5
	-125423	<b>626400-PG5</b>	205-2, 205-3, 206-2, 207-2, 207-3	<b>27</b>	<b>G 3/4"</b>	1	5
-236488	<b>626465-PG7</b>	18-3-DK	<b>27</b>	<b>G 3/4"</b>	1	7	
G 1"	-875564	<b>633350-PG6</b>		<b>36</b>	<b>G 1"</b>	1	6
	-068669	<b>633425-PG6</b>	18-4	<b>27</b>	<b>G 1"</b>	1	6
	-893452	<b>633500-PG7</b>		<b>36</b>	<b>G 1"</b>	1	7
	-866388	<b>633600-PG7</b>	12-6, 12-7	<b>36</b>	<b>G 1"</b>	1	7
G 1 1/8"	-893469	<b>637500-PG9</b>		<b>41</b>	<b>G 1 1/8"</b>	1	9
	-169236	<b>637600-PG9</b>	18-5, 20-5, 205-4, 207-4	<b>41</b>	<b>G 1 1/8"</b>	1	9
	-955599	<b>699999</b>	Spezialfett für Spindeln			1	1



### Zubehör/Accessories

#### 600-17

Pressure pad bricks  
Jeu d'embouts de pression  
Juego de piezas de presión  
Spindeldrukstukken set



EAN-Code	Art.-No.	Ø mm		Euro
4021176-914188	600-17	20, 32, 41	1	20,20

### 728 Sicherungszangen für Außenringe

Circlip pliers, external  
Pincas pour circlips extérieurs  
Alicates para segmentos de retención exteriores  
Segerring tangen voor uitwendige ringen



EAN-Code	Art.-No.		mm	mm		Euro
4021176-139567	728T-A0	gerade straight à becs droits	135	A0 = 3-10	6	20,00
-790546	728T-A1		135	A1 = 10-25	6	20,20
-790560	728T-A2		180	A2 = 19-60	6	20,20
-545764	728T-A3		225	A3 = 40-100	6	29,10
-790591	728T-A4		320	A4 = 85-140	6	42,60
-545757	728T-A01	gebogen angled à becs coudés	135	A01 = 3-10	6	21,50
-790553	728T-A11		135	A11 = 10-25	6	21,50
-790577	728T-A21		180	A21 = 19-60	6	23,90
-790584	728T-A31		225	A31 = 40-100	6	29,10
-545771	728T-A41		320	A41 = 85-140	6	42,60

### 729 Sicherungszangen für Innenringe

Circlip pliers, internal  
Pincas pour circlips intérieurs  
Alicates para segmentos de retención interiores  
Segerring tangen voor inwendige ringen



EAN-Code	Art.-No.		mm	mm		Euro
4021176-139574	729T-J0	gerade straight à becs droits	135	J0 = 3-10	6	17,90
-545788	729T-J1		135	J1 = 10-25	6	17,90
-545801	729T-J2		180	J2 = 19-60	6	17,90
-545825	729T-J3		225	J3 = 40-100	6	23,90
-545726	729T-J4		320	J4 = 85-140	6	40,30
-139581	729T-J01	gebogen angled à becs coudés	135	J01 = 3-10	6	20,20
-545795	729T-J11		135	J11 = 10-25	6	20,20
-545818	729T-J21		180	J21 = 19-60	6	20,20
-545832	729T-J31		225	J31 = 40-100	6	24,70
-545849	729T-J41		320	J41 = 85-140	6	40,30

### 728 Sicherungszangen Service Satz

Circlip Pliers Service Set  
Pincas à circlips, jeu pour le service après vente  
Juego de servicio de alicates para segmentos de retención  
Segerring-tangen service-set



Satz/Set/Jeu  
728T-A1, 728T-A11, 728T-A2, 728T-A21  
729T-J1, 729T-J11, 729T-J2, 729T-J21

EAN-Code	Art.-No.		Euro
4027474-647734	728T729	8-tlg./parts	240,80

### TIPP: 128-4, 128-5, 129-5

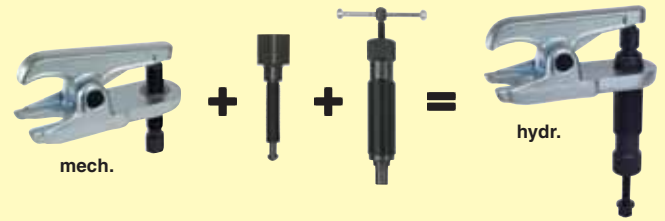

$$\begin{array}{l}
 128-4 + 800-801 + 801 \\
 128-5 + 800-801 + 801 \\
 129-5 + 800-801 + 801
 \end{array}
 = \text{hydr.}$$

### 800 Hydraulische Spindeln

Hydraulic screws  
Vis hydrauliques  
Husillos hidráulicos  
Hydraulische spindel

austauschbar/  
exchangeable

Produktaufwertung!  
Technical innovation!



10+15+20 to  
**hydraulic**  
TECHNOLOGY

EAN-Code	Art.-No.	G	to		Euro
4021176-034343	800	G 1.1/2"-16	10	1	133,40
-784446	801	G 1.1/2"-16	15	1	253,40
-784514	802	M 40 x 1,5	20	1	333,40
-244483	800-ERS	Zubehör/Accessories		1	64,60
-238123	800-REP	Zubehör/Accessories		1	113,60
-788086	801 ERS	Zubehör/Accessories		1	105,10
-788161	801-REP	Zubehör/Accessories		1	140,30
-788246	802-ERS	Zubehör/Accessories		1	105,10
-788321	802-REP	Zubehör/Accessories		1	140,30

### 800



EAN-Code	Art.-No.	mm		Euro
4021176-031113	800-050	50	1	10,30
-031298	800-100	100	1	11,60
-031373	800-150	150	1	15,00

### 800-626 Mechanische Schlag-Schockspindel

Mechanical pressure screw  
Vis d'extraction mécanique  
Husillo mecánico  
Mechanische spindel  
Vite meccanica



G 1.1/2"-16

Neue Ausführung, mit zusätzlicher Schlag/Schock Funktion  
New, designed for additional impact-shock action  
Exécution nouveaux pour coup de marteaux action supplémentaire  
Modelo nuevo con funcionamiento de golpe/choque adicional  
Nieuwe uitvoering met additionele slagfunctie  
Nuovo costruzione, per martellate vite presserato in casi de pezzi bloccati a fondo

EAN-Code	Art.-No.	passend zu suitable for/s/adaptant à/geschikt voor	Euro
4021176-969980	800-626	No. 818-0, 820-0, 844, 845	170,00

### 800-801 Hydraulikspindel-Adapter

Reduzierstück für hydraulischen Spindeln 800 und 801 zum Einsatz an mechanischen Abziehern mit Innengewinde G 5/8"  
Adapter for use of hydr. screws Nos. 800 and 801 on extracting tools with center hole having internal thread G 5/8"  
Pièce de réduction de vis No. 800 et de vis 8001 pour l'utilisation avec outillage d'extraction avec filet centrale de G 5/8"  
Pieza de reducción para utilizar husillos hidráulicos 800 y 801 con herramientas con rosca central de G 5/8"  
Reduceerstuk om hydraulische spindel 800 of 801 te gebruiken met mechanische trekkers met spindelschroefdraad G 5/8"  
Raccordo di riduzione per uso de vite idraulica num. 800 et num. 801 con estrattori con filetto interno de G 5/8"



G 5/8"

EAN-Code	Art.-No.		Euro
4021176-923081	800-801	für/for/pour/para 129-5, 128-4, 128-5	117,00



### 818-0

Pulling device with hydraulic screw  
 Extracteur à tirants avec vis hydraulique  
 Dispositivo de extracción con husillo hidráulico  
 Hulptrekker met hydraulische spindel



**hydraulic**  
TECHNOLOGY

ST	EAN-Code	Art.-No.	mm	mm	Euro
	4021176-173196	818-0	240	280	1 393,90

### 818-021

Internal extractor  
 Extracteur intérieur  
 Extractor interior  
 Binnentrekker

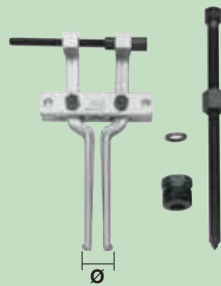

ST	EAN-Code	Art.-No.	für for/pour No. 818-0	Ø mm	Euro
	4021176-757969	818-021	No. 818-0	30 - 180	1 355,40

### 818

Pulling bolts and extensions  
 Tirants et rallonges de tirants  
 Tirantes y alargaderas de tirantes  
 Trekbouten en verlengstukken



ST	EAN-Code	Art.-No.	für for/pour No. 818-0	L mm	Euro
	4021176-173356	818-250	No. 818-0	250	1 28,80
31	4021176-173431	818-280	No. 818-0	250	1 77,50

### 818-100

Hydraulic bearing puller set  
 Jeu d'arrache-roulements hydraulique  
 Juego de extractores hidráulicos de cojinetes  
 Hydraulisch lagertrekker-set

**hydraulic**  
TECHNOLOGY

ABZ 200-H



ST	EAN-Code	Art.-No.	mm	Ø-mm	Euro
	4021176-717611	818-100	500	25-100	1 664,20

### 818-150

Hydraulic bearing puller set  
 Jeu d'arrache-roulements hydraulique  
 Juego de extractores hidráulicos de cojinetes  
 Hydraulisch lagertrekker-set

**hydraulic**  
TECHNOLOGY

ABZ 250-H



ST	EAN-Code	Art.-No.	mm	Ø-mm	Euro
	4021176-717796	818-150	500	25-150	1 807,80

### 818-215

Hydraulic bearing puller and extractor set  
 Jeu hydraulique de décolleurs et extracteurs de roulements  
 Juego de separadores y extractores hidráulicos de cojinetes  
 Hydraulisch lagerscheider- en trekker-set



**hydraulic**  
TECHNOLOGY

ST	EAN-Code	Art.-No.	Satz/Set/Jeu	Euro
	4021176-173271	818-215		1 1431,80

## NEU bei KUKKO: Tanos® Systemainer

Der Tanos-KUKKO-Koffer ist mit allen Tanos-Systemkoffern kombinierbar, so dass alle Werkzeuge sicher aufbewahrt und transportiert werden können.



### 820

Hydraulic 2-arm puller  
 Extracteur hydraulique à 2 bras  
 Extractor hidráulico de 2 brazos  
 2-armige hydraulische trekker

**hydraulic**  
TECHNOLOGY

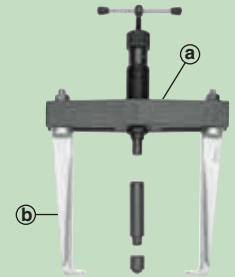

mit immer parallelen Gleithaken  
 with constantly parallel claws  
 à griffes toujours parallèles  
 con garras siempre paralelas  
 met steeds parallel blijvende trekhaken

ST	EAN-Code	Art.-No.	mm	mm	Euro
	4021176-173684	820-0	225	225	1 433,80
	4021176-173509	818-820	a) Zubehör/Accessories		1 187,40
	4021176-173769	820-225	b) Zubehör/Accessories		1 75,50

### 844/845

Hydraulic pullers,  
 Extracteurs hydrauliques,  
 Extractores hidráulicos,  
 Hydraulische trekkers,

selbstzentrierend  
 self-centering  
 autocentreuse  
 autocentrantes  
 zelfcentrerend



844-1-B  
 844-2-B  
 844-3-B  
 844-4-B

**hydraulic**  
TECHNOLOGY



845-1-B  
 845-2-B  
 845-3-B  
 845-4-B

ST	EAN-Code	Art.-No.	mm	mm	Euro
	4021176-031601	844-1-B	50-100	100	1 248,40
	4021176-031946	844-2-B	75-150	150	1 259,20
	4021176-032448	844-3-B	75-150	250	1 285,00
	4021176-076091	844-4-B	100-200	200	1 280,20
	4021176-032776	844-5-B	130-250	250	1 310,40
	4021176-033278	845-1-B	50-100	100	1 301,40
	4021176-033438	845-2-B	75-150	150	1 322,80
	4021176-033681	845-3-B	75-150	250	1 334,30
	4021176-033841	845-4-B	100-200	200	1 344,70
	4021176-034008	845-5-B	130-250	250	1 355,90

### 844/845

Individual parts  
Pièces détachées



ST	EAN-Code 4021176-	Art.-No.	für for/pour		Euro
	-031458	844-000	No. 844	1	54,30
	-135651	844-020	No. 844, 845	1	24,80
	-075919	844-100	No. 844-1-B, 845-1-B	1	46,40
	-031861	844-150	No. 844-2-B, 845-2-B	1	46,40
	-032363	844-200	No. 844-4-B, 845-4-B	1	55,60
	-032103	844-250	No. 844-3-B, 845-3-B	1	44,40
	-032691	844-251	No. 844-5-B, 845-5-B	1	77,50
	-033018	845-000	No. 845	1	61,80

### 844-626

Mechanical pressure screw  
Vis d'extraction mécanique  
Husillo mecánico  
Mechanische spindel  
Vite meccanica

*Neue Ausführung siehe No. 800-626*  
*New model, see No. 800-626*  
*Version nouveaux, voir No. 800-626*  
*Para modelo nuevo, vea No. 800-626*  
*Voor nieuwe uitvoering, zie No. 800-626*  
*Per nuova costruzione, vedi No. 800-626*

G 1.1/2"-16



ST	EAN-Code 4021176-	Art.-No.	passend zu suitable for/s'adaptant à/geschikt voor		Euro
	-032851	844-626	No. 818-0, 820-0, 844, 845	1	88,20

### 845-150

Hydraulic „6 Puller“ - Set  
Jeu de 6 extracteurs hydrauliques  
Juego de 6 extractores hidráulicos  
Hydraulische „6 trekkers“ - set

selbstzentrierend  
self-centering  
autocentreuses  
autocentrante  
zelfcentrerend



ABZ 100-H  
845-150

ST	EAN-Code 4021176-	Art.-No.	mm	mm		Euro
	-717871	845-150	50-150	150	1	555,50

### 845-250

Hydraulic „6 Pullers“- Set  
Jeu de 6 extracteurs hydrauliques  
Juego de 6 extractores hidráulicos  
Hydraulische „6 trekkers“ - set

selbstzentrierend  
self-centering  
autocentreuses  
autocentrante  
zelfcentrerend



ABZ 150-H  
845-250

ST	EAN-Code 4021176-	Art.-No.	mm	mm		Euro
	-717956	845-250	75-250	250	1	800,20

### 845-851

Hydraulic „10 Puller“ -Set  
Jeu hydraulique de „10 extracteurs“  
Juego de „10 extractores“ hidráulicos  
Hydraulisch set „10 trekkers“

**hydraulic**  
TECHNOLOGY



selbstzentrierend  
self-centering  
autocentreuses  
autocentrante  
zelfcentrerend



ST	EAN-Code 4021176-	Art.-No.	Satz /Set /Jeu		Euro
	-172854	845-851		1	1049,00

### 845-855

Hydraulic gear and bearing puller Set  
Jeu hydraulique d'arrache-roues et arrache-roulement  
Juego de extractores hidráulicos universales  
Universele hydraulische trekker set

selbstzentrierend  
self-centering  
autocentreuses  
autocentrante  
zelfcentrerend



**hydraulic**  
TECHNOLOGY



ST	EAN-Code 4021176-	Art.-No.	Satz /Set /Jeu		Euro
	-172939	845-855		1	1728,70

### 845-858

Hydraulic Universal Puller and Extractor Set  
Jeu "Universel" hydraulique de décolleurs et extracteurs  
Juego hidráulico de extracción universal  
Universeel hydraulisch lagerscheider en trekker-set

selbstzentrierend  
self-centering  
autocentreuses  
autocentrante  
zelfcentrerend



**hydraulic**  
TECHNOLOGY

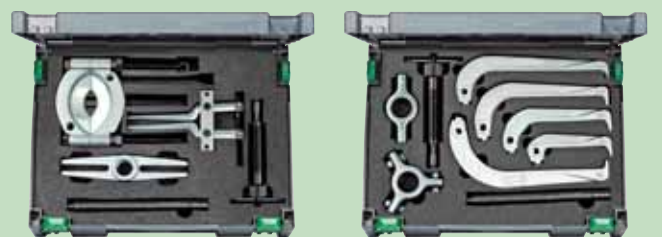

ST	EAN-Code 4021176-	Art.-No.	Satz /Set /Jeu		Euro
	-173011	845-858		1	2085,50



Modell bestellen unter:  
LKW-04-2 PG3



880

Universal press frame  
Huisserie à presse

für Silentbuchsen

10 + 15 + 20 to  
**hydraulic**  
TECHNOLOGY

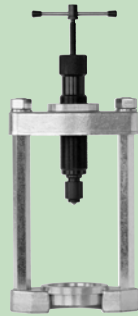

ST	EAN-Code	Art.-No.		to		Euro
	4021176-					
	-433689	880-800	mit / with / avec No. 800	10	1	414,40
	-433696	880-801	mit / with / avec No. 801	15	1	521,60
	-433702	880-802	mit / with / avec No. 802	20	1	608,60

880

Pressure piece kits for universal press frame  
Patin de serrage pour huisserie à presse

für/for/pour/para PKW



ST	EAN-Code	Art.-No.	für / for / pour / para	-teilig -parts		Euro
	4021176-					
	-433610	880-114	DB W124, 201, 129	3	1	139,20
	-433627	880-137	BMW (3er), E36	4	1	249,20
	-433634	880-144	VW T4 (92)	4	1	289,90
	-433658	880-147	VW LT, DB Sprinter	4	1	550,70

880

Press and pulling sleeve kit  
Set à depresser et detirer douilles

für/for/pour/para PKW + LKW



ST	EAN-Code	Art.-No.	Inhalt contents/contenu/inhoud		Euro
	4021176-				
	-433672	880-400	28-teilig / parts	1	811,50

Micro

Small-part puller  
Extracteur pour mécanique de précision  
Extractor para mecánica de precisión  
Trekker voor fijnmechanika

z.B. für Tachowellen VDO  
e. g. for speedometer cable puller  
p. ex. pour flexibles de tachymètres  
p. ej. para árboles flexibles de tacómetros  
bijv. voor tachograafassen

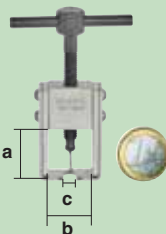

ST	EAN-Code	Art.-No.	a mm	b mm	c mm		Euro
	4021176-						
	-974755	Micro	20	18	5	1	60,40



EVLW-D

Rotary display  
Écran de rotation



1 2 3 4 5



ST	EAN-Code	Art.-No.	Dreh-Display Rotary display / écran de rotaion		Euro
	4021176-				
	314377	EVLW-D-1	incl. 3 Tafeln / tables 1 2 3	1	133,00
	314384	EVLW-D-2	incl. 3 Tafeln / tables 2 4 5	1	133,00

Wir besuchen Sie gerne mit unserem KUKKO-Vorfühswagen.  
Rufen Sie uns an.

We will be pleased to visit you with our demonstration car.  
Please call us.

+49 (0) 2191/9339-0





### AVLW-1 KUKKO-Verkaufswände

**EVLW-1** KUKKO- Merchandisers  
Présentoirs KUKKO  
KUKKO- Expositores  
KUKKO-Verkoopwanden

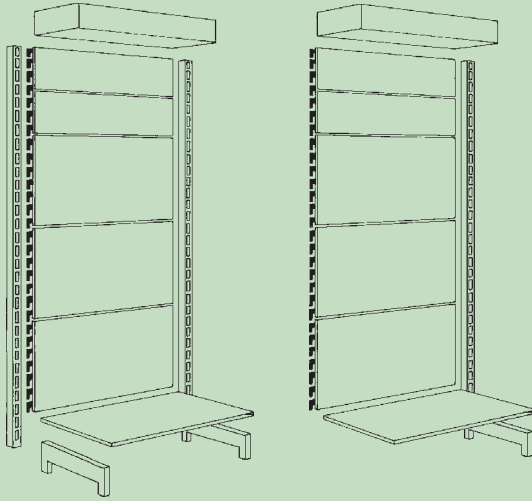

EVLW-1

AVLW-1

83	EAN-Code	Art.-No.		Euro
ST	4021176-449093	AVLW-1	1	1390,40
	448911	EVLW-1	1	1574,00
	875724	VLWH-1	1	77,50

### EVLW-20 KUKKO-Verkaufswand Automotive

Merchandiser, automotive tools  
Présentoir de vente, outillage pour l'automobile  
Expositor de venta, herramientas para automoviles  
Verkoopwand, automobil-gereedschap

**TOP 100  
Automotive**

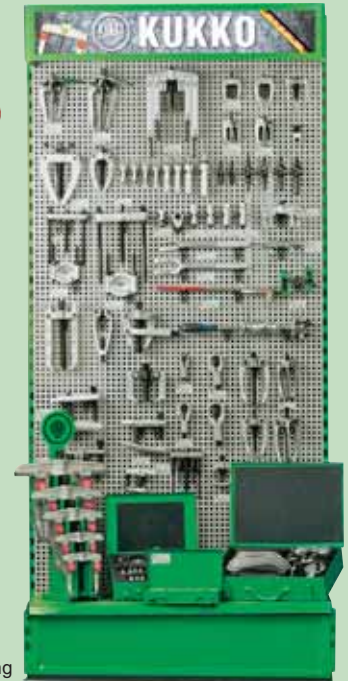

Beispielabbildung

ST	EAN-Code	Art.-No.	Inhalt contents / contenu / inhoud	Euro
	4021176-909597	EVLW-20	<a href="http://www.KUKKO.com/EVLW-20">www.KUKKO.com/EVLW-20</a>	6271,00

### EVLW-10 KUKKO-Verkaufswand Industrie

Merchandiser, industrial pullers  
Présentoir de vente, outillage pour l'industrie  
Expositor de venta, herramientas para industria  
Verkoopwand, industrie-gereedschap

**TOP 100  
Industrie**

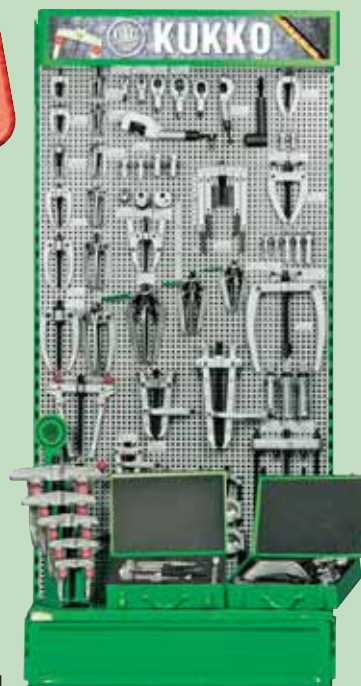

Beispielabbildung

ST	EAN-Code	Art.-No.	Inhalt contents / contenu / inhoud	Euro
	4021176-909580	EVLW-10	<a href="http://www.KUKKO.com/EVLW-20">www.KUKKO.com/EVLW-20</a>	6949,40

### EVLW-30 KUKKO-Verkaufswand Kugellager (SKF)

Merchandiser, roller bearing tools  
Présentoir de vente, arrache-roulements  
Expositor de venta, herramientas para cojinetes de bolas  
Verkoopwand, kogellager-trekkers

**TOP 100  
SKF**



Beispielabbildung

ST	EAN-Code	Art.-No.	Inhalt contents / contenu / inhoud	Euro
	4021176-909603	EVLW-30	<a href="http://www.KUKKO.com/EVLW-30">www.KUKKO.com/EVLW-30</a>	6898,60





**KUKKO**

**KUKKO**

Es sind auch Eckvarationen möglich.  
**Fordern Sie unsere Broschüre an!**

A lot of variation are possible.  
**Make an application for our leaflet!**



Gerne stellen wir Ihnen eine individuelle Verkaufswand zusammen!  
Please ask us for our individual sales booth.



Dreh-Display mit  
verschiedenen Info-Tafeln  
für Ihre Abzieher-Präsentation.  
Siehe Seite 54.

Rotatable - illustrated chart  
with different info-panells for  
puller-presentation.  
See page 54.

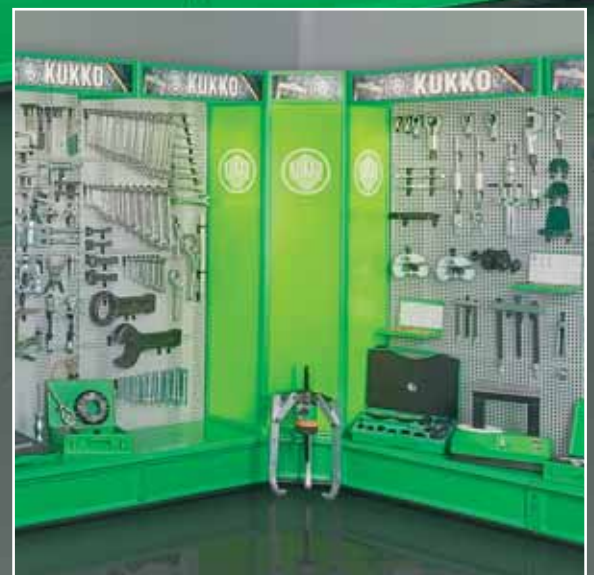



### K-20-15 Universal Abzieh- und Trennvorrichtungssatz

Universal puller set with separator  
 Jeu d'extracteurs universels avec décolleur  
 Juego de extractores y dispositivo extractor  
 Universeel trekker en mestrekker set

15 to  
**hydraulic**  
 TECHNOLOGY



13 ST	EAN-Code	Art.-No.	Inhalt	1	Euro
	4021176-	K-20-15	contents/contenu/inhoud		
	-367311		20-1, 20-2, 1-190-P, 2-300-P, 15-2, 9-2		849,80

### K-2030-10 2- und 3-armiger Universalabzieher-Satz

Set of two- and three-arm pullers  
 Jeu d'extracteurs universels à 2- et 3 bras  
 Juego de extractores universales de 2 y 3 brazos  
 2- en 3-armige universele trekkers-set

Inhalt / contents:  
 20-10-P3 30-10-P3 614250



11 ST	EAN-Code	Art.-No.		mm		mm	1	Euro
	4021176-	K-2030-10		120		100-350		
	-974748							324,40

### K-65-A KFZ Universal Werkstattgarnitur

Set of universal automotive repair shop tools  
 Jeu universel pour ateliers automobiles  
 Juego universal para taller de automóviles  
 Universeel werkplaatsset voor personenwagens



79 ST	EAN-Code	Art.-No.	Satz/Set/Jeu	1	Euro
	4021176-	K-65-A	Univers.		
	-412851				883,40

### K-2030-10-S 2- und 3-armiger Universalabzieher-Satz

Set of two- and three-arm pullers  
 Jeu d'extracteurs universels à 2- et 3 bras  
 Juego de extractores universales de 2 y 3 brazos  
 2- en 3-armige universele trekkers-set

Inhalt / contents:  
 20-10-SP 30-10-SP 614250



für enge Zwischenräume  
 for confined spaces  
 pour interstices étroits  
 para intersticios angostos  
 voor nauwe tussenruimtes



Extrem schmale Abzughaken!  
 Extremely small pulling arms!

11 ST	EAN-Code	Art.-No.		mm		mm	1	Euro
	4021176-	K-2030-10-S		120		100-350		
	-306181							477,40

### KS-142/6 Universal Scheibenwischer-Abziehersatz

Universal wiper arm puller set  
 Jeu universel d'extracteurs de bras d'essuie-glaces  
 Juego de extractores para brazos de limpiaparabrisas  
 Univ. trekker set voor ruitenwisser-armen



- Kompletter Satz für VW, Audi, Seat, Skoda bis BJ 2008 und andere
- Complete Set for VW, Audi, Seat, Skoda up to 2008 and other
- Juego completo para VW, Audi, Seat, Skoda a año de construcción 2008 et alii
- Jeu complete pour VW, Audi, Seat, Skoda jusque année de construction 2008 et alii

11 ST	EAN-Code	Art.-No.	Inhalt	1	Euro
	4021176-	KS-142/6	contents / contenu / inhoud		
	-555565		142-1; 142-2; 142-3; 142-4; 128-F-SW; 43-1		407,50

### K-20204 PKW Abziehwerkzeug-Satz

Set of pulling tools for passenger cars  
 Jeu d'extracteurs pour véhicules de tourisme  
 Juego de extractores para automóviles  
 Set personenwagen  
 trekgereedschap

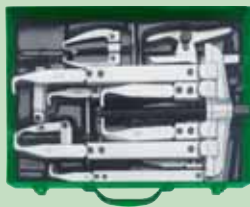

83 ST	EAN-Code	Art.-No.	Satz/Set/Jeu	1	Euro
	4021176-	K-20204			
	-744433				815,40

### K-20210 LKW Abziehwerkzeug-Satz

Set of pulling tools for trucks  
 Jeu d'extracteurs pour camions  
 Juego de extractores para camiones  
 Set vrachtwagen  
 trekgereedschap

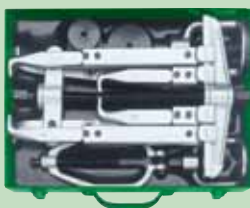

83 ST	EAN-Code	Art.-No.	Satz/Set/Jeu	1	Euro
	4021176-	K-20210	LKW / Trucks / Camions		
	-744501				986,70

### K-203 2- und 3-armige Abzieher-Satz

Set of 2- and 3-arm Pullers  
 Jeu de extracteurs à 2- et a 3-bras  
 Juego de extractores de 2 y de 3 brazos  
 2- en 3-armige trekkers-set



mit umkehrbaren Abzughaken  
 with reversible double-end jaws  
 à griffes d'extraction réversibles  
 con garras reversibles  
 met omkkeerbare trekhaken

34 ST	EAN-Code	Art.-No.	Satz/Set/Jeu	1	Euro
	4021176-	K-203			
	-280351				307,50

### P-203 2- und 3-armige Abzieher-Satz

Set of 2- and 3-arm Pullers  
 Jeu de extracteurs à 2- et a 3-bras  
 Juego de extractores de 2 y de 3 brazos  
 2- en 3-armige trekkers-set



#### Display-Pack



mit umkehrbaren Abzughaken  
 with reversible double-end jaws  
 à griffes d'extraction réversibles  
 con garras reversibles  
 met omkkeerbare trekhaken

11 ST	EAN-Code	Art.-No.	Satz/Set/Jeu	1	Euro
	4021176-	P-203			
	-280764				245,60



### K-20315 2- und 3-armige Abzieher mit Trennvorrichtung

Set of two- and three-arm pullers with separator  
 Jeu d'extracteurs à 2- et 3 bras avec décolleur  
 Extractores de 2 y de 3 brazos y separador  
 Twee- en drie-armige trekkers met mestrekker-set

mit umkehrbaren Abzughaken  
 with reversible double-end jaws  
 à griffes d'extraction réversibles  
 con garras reversibles  
 met omkeerbare trekhaken



34 ST	EAN-Code 4021176-	Art.-No.	Satz/Set/Jeu	1	Euro 497,50
	-280504	K-20315			

### K-20715 2- und 3-armige Abzieher mit Trennvorrichtung-Satz

Set of two- and three-arm pullers with separator  
 Jeu d'extracteurs à 2- et 3 bras avec décolleur  
 Juego de extractores de 2 y de 3 brazos con separador  
 Twee- en drie-armige trekkers met mestrekker-set

mit verstellbarer Spanntiefe  
 with adjustable reach  
 à profondeur réglable  
 con profundidad regulable  
 met verstelbare spandiepte



35 ST	EAN-Code 4021176-	Art.-No.	Satz/Set/Jeu	1	Euro 461,80
	-280689	K-20715			

### P-20315 2- und 3-armige Abzieher mit Trennvorrichtung

Set of two- and three-arm pullers with separator  
 Jeu d'extracteurs à 2- et 3 bras avec décolleur  
 Extractores de 2 y de 3 brazos y separador  
 Twee- en drie-armige trekkers met mestrekker-set

#### Display-Pack

mit umkehrbaren Abzughaken  
 with reversible double-end jaws  
 à griffes d'extraction réversibles  
 con garras reversibles  
 met omkeerbare trekhaken



34 ST	EAN-Code 4021176-	Art.-No.	Satz/Set/Jeu	1	Euro 435,80
	-280924	P-20315			

### P-20715 2- und 3-armige Abzieher mit Trennvorrichtung-Satz

Set of two- and three-arm pullers with separator  
 Jeu d'extracteurs à 2- et 3 bras avec décolleur  
 Juego de extractores de 2 y de 3 brazos con separador  
 Twee- en drie-armige trekkers met mestrekker-set

#### Display Pack

mit verstellbarer Spanntiefe  
 with adjustable reach  
 à profondeur réglable  
 con profundidad regulable  
 met verstelbare spandiepte



35 ST	EAN-Code 4021176-	Art.-No.	Satz/Set/Jeu	1	Euro 408,80
	-281006	P-20715			

### K-207 2- und 3-armige Abzieher-Satz

Set of two- and three-arm pullers  
 Jeu d'extracteurs à 2- et 3 bras  
 Juego de extractores de 2 y de 3 brazos  
 Twee- en drie-armige trekkers-set

mit verstellbarer Spanntiefe  
 with adjustable reach  
 à profondeur réglable  
 con profundidad regulable  
 met verstelbare spandiepte



34 ST	EAN-Code 4021176-	Art.-No.	Satz/Set/Jeu	1	Euro 286,70
	-280436	K-207			

### P-207 2- und 3-armige Abzieher-Satz

Set of two- and three-arm pullers  
 Jeu d'extracteurs à 2- et 3 bras  
 Juego de extractores de 2 y de 3 brazos  
 Twee- en drie-armige trekkers-set

#### Display-Pack

mit verstellbarer Spanntiefe  
 with adjustable reach  
 à profondeur réglable  
 con profundidad regulable  
 met verstelbare spandiepte



34 ST	EAN-Code 4021176-	Art.-No.	Satz/Set/Jeu	1	Euro 216,40
	-280849	P-207			

207



### KS-22 Gleithammersatz

Set of slide hammer  
 Jeux de dispositifs à masse coulissante  
 Juegos de martillos de correa  
 Glijhamer- gereedschap-sets

KS-22-01  
 Gewindestift  
 austauschbar!



KS-22-02 für die Landwirtschaft + LKW  
 for the agriculture + LKW  
 pour la agriculture + LKW

10-teilig/parts

34 ST	EAN-Code 4021176-	Art.-No.	Inhalt: contents/contenu/inhoud	1	Euro 117,00
	-924569	KS-22-01	Adapter: M3; M4; M5; M6; M8; M10; verzinkt/zinc-plated: M7; M10; 15-16G; 22-01-GH = M12		
	-951121	KS-22-02	Adapter: M6; M8x1; M10; M10x1; M12x1; M15x1,5 verzinkt/zinc-plated: M7; M10; 15-16G; 22-01-GH = M12	1	117,00



### KS-222-1/7 Dichtring-Ausziehsatz (Simmerringe)

NEU-NEW

für Simmerringe, Dichtringe etc.

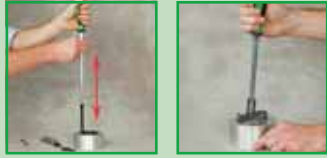

EAN-Code	Art.-No.	Inhalt contents/contenu/inhoud	-teilig -parts		Euro
4021176-111112	KS-222-1/7	222-1; 222-1-100; 222-1-250; 222-1-50S; 222-U; 222-E; 222-P	9	1	277,20

### KS-70-A-K Kugellager Abziehsatz (Patent angemeldet)

Ball bearing extractor set  
Jeu d'arrache-roulements  
Juego de extracción  
Kogellagertrekker set

für Rillenkugellager  
for deep-groove ball bearings  
pour roulements rainurés à billes  
para cojinetes de bolas ranurados  
voor groefkogellagers



EAN-Code	Art.-No.			Euro
4021176-956362	KS-70-A-K	6000-6012/6200-6212/6300-6311/6403-6408	1	1049,00

### UFP Unfallschutz-Planen

Protective blankets  
Toiles de protection  
Cubiertas de lona  
Veiligheids-beschermhoezen

für Abzieharbeiten  
for pulling jobs  
pour travaux de démontage et  
d'extraction  
para proteger contra accidentes  
voor trekwerkzaamheden



92	EAN-Code	Art.-No.			Euro
	4021176-869853	UFP-1	500 x 1100 mm	1	199,20
	4021176-869860	UFP-2	670 x 1500 mm	1	224,00
	4021176-869877	UFP-3	1300 x 4000 mm	1	925,50

### WT-000 Wand Tafel, unbestückt

Wall Panel, only  
Panneau mural pas équipé  
Panel mural, sin equipar  
Wandbord, leeg

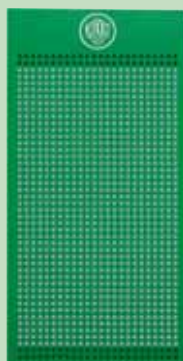

ST	EAN-Code	Art.-No.			Euro
	4021176-890550	WT-000	500 x 1000 mm	1	129,10

### WT-002 Universal Abzieher -Industrie Satz-

Universal pullers - industrial set -  
Extracteur universel - Jeu industriel -  
Extractores universal - Juego para la industria -  
Universele trekkers -industrie set-

Quick adjust  
TECHNOLOGY

10 to  
hydraulic  
TECHNOLOGY

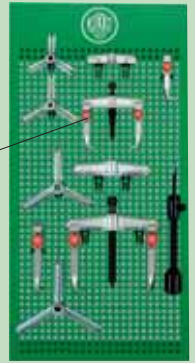

ST	EAN-Code	Art.-No.	Satz/Set/Jeu/Juego/Set		Euro
	4021176-890567	WT-002		1	1051,90

### WT-003 Universal Abzieher -Industrie Satz-

Universal pullers - industrial set -  
Extracteur universel - Jeu industriel -  
Extractores universal - Juego para la industria -  
Universele trekkers -industrie set-

Satz, ohne hydraulische Spindel  
Set, without hydraulic screw  
Jeu, sans vis hydraulique  
Juego, sins husillo hidráulico  
Set, zonder hydraulische spindel

Quick adjust  
TECHNOLOGY

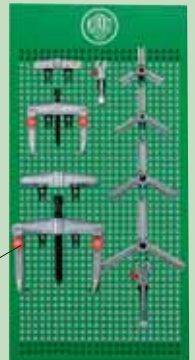

ST	EAN-Code	Art.-No.	Satz/Set/Jeu/Juego/Set		Euro
	4021176-890574	WT-003		1	835,40

### WT-004 Universal Werkzeuge PKW -Basis Satz-

Universal passenger-car tools - basic set -  
Outillage universel voitures - Jeu de base -  
Herramientas universales para automóviles  
- Juego base -  
Universeel gereedschap personenwagens  
- basis set -

Quick adjust  
TECHNOLOGY

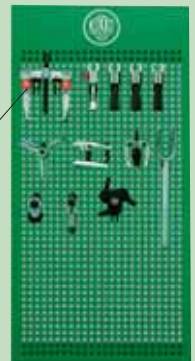

ST	EAN-Code	Art.-No.	Satz/Set/Jeu/Juego/Set		Euro
	4021176-890581	WT-004		1	822,60

### WT-006 Spezial Werkzeuge PKW

Special-purpose passenger-car tools  
Outillage spécial voitures  
Herramientas especiales para automóviles  
Speciaal gereedschap personenwagens

Quick adjust  
TECHNOLOGY

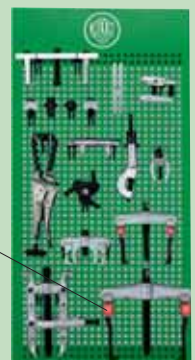

ST	EAN-Code	Art.-No.	Satz/Set/Jeu/Juego/Set		Euro
	4021176-890598	WT-006		1	1648,80



### WT-008 Universal Werkzeuge LKW -Basis Satz-

Universal truck tools - basic set -  
 Outillage universel camions - Jeu de base -  
 Herramientas universales para camiones -  
 - Juego base -  
 Universeel gereedschap vrachtwagens  
 - basis set -



10 to  
**hydraulic**  
 TECHNOLOGY

	EAN-Code	Art.-No.	Satz/Set/Jeu/Juego/Set		Euro
	4021176-890604	WT-008		1	1145,80

### WT-016 Allgemeine Instandsetzung

General Engineering  
 Réparation générale  
 Reparaciones en general  
 Algemeen onderhoud

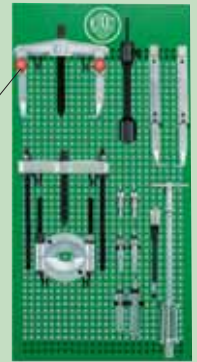

**Quick adjust**  
 TECHNOLOGY

10 to  
**hydraulic**  
 TECHNOLOGY

	EAN-Code	Art.-No.	Satz/Set/Jeu/Juego/Set		Euro
	4021176-893483	WT-016		1	1411,10

### WT-009 Universal Werkzeuge - LKW Fahrwerk -

Universal truck-chassis tools  
 Outillage universel - Châssis de camions -  
 Herramientas universales  
 - Bastidor de camiones -  
 Universeel gereedschap  
 - vrachtwagen chassis -



7 + 10 to  
**hydraulic**  
 TECHNOLOGY

	EAN-Code	Art.-No.	Satz/Set/Jeu/Juego/Set		Euro
	4021176-890611	WT-009		1	1675,00

### WT-030 Spezial Werkzeuge - BPW-Achsen -

Special-purpose tools - BPW axles -  
 Outillage spécial - Essieux BPW -  
 Herramientas especiales -Ejes BPW-  
 Speciaal gereedschap -BPW assen-

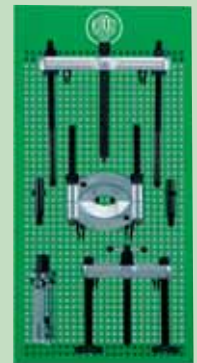

#### 18-3BPW Satz im Metallkasten

Set in metal case  
 Jeu en coffret métallique  
 Juego en caja metálica  
 Set in metalen kist

	EAN-Code	Art.-No.	Satz/Set/Jeu/Juego/Set		Euro
	4021176-893490	WT-030	auf Wandtafel / on wall panel	1	895,90
	-914591	18-3-BPW	im Metallkasten / in metal case	1	895,90

### WT-010 Abziehwerkzeuge Schwere LKW - Basis Satz-

Pulling devices for heavy trucks  
 - basic set -  
 Outillage d'extraction poids lourds  
 - Jeu de base-  
 Herramientas extractoras para camiones  
 pesados - Juego base -  
 Trekgereedschap zware vrachtwagens  
 -basis set-

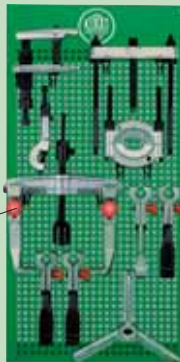

**Quick adjust**  
 TECHNOLOGY

10 + 15 to  
**hydraulic**  
 TECHNOLOGY

	EAN-Code	Art.-No.	Satz/Set/Jeu/Juego/Set		Euro
	4021176-890628	WT-010		1	2061,10

### WT-031 Spezial Werkzeuge - SAF-Achsen -

Special-purpose tools - SAF axles -  
 Outillage spécial - Essieux SAF -  
 Herramientas especiales -Ejes SAF-  
 Speciaal gereedschap -SAF assen-

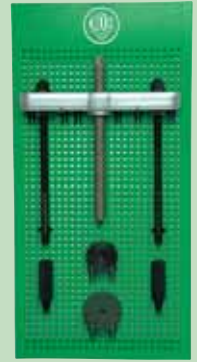

#### 18-4SAF Satz im Metallkasten

Set in metal case  
 Jeu en coffret métallique  
 Juego en caja metálica  
 Set in metalen kist

	EAN-Code	Art.-No.	Satz/Set/Jeu/Juego/Set		Euro
	4021176-914584	WT-031	auf Wandtafel / on wall panel	1	843,40
	-465246	18-4SAF	im Metallkasten / in metal case	1	843,40

### WT-014 Universal Werkzeuge - PKW Lenkung -

Universal passenger-car tools - steering -  
 Outillage universel - Direction voitures -  
 Herramientas universales  
 -Dirección de automóviles -  
 Univers. gereedschap  
 -personenwagens stuurinrichting-

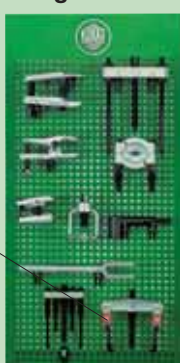

**Quick adjust**  
 TECHNOLOGY

10 to  
**hydraulic**  
 TECHNOLOGY

	EAN-Code	Art.-No.	Satz/Set/Jeu/Juego/Set		Euro
	4021176-890635	WT-014		1	1208,70

### WT-50 Universal-Abzieher-Satz auf Lochtafel

Universal puller set on wall panel  
 Jeu d'extracteurs universels sur panneau  
 Juego de extractores universales en panel mural  
 Universeel trekker-set op wandbord

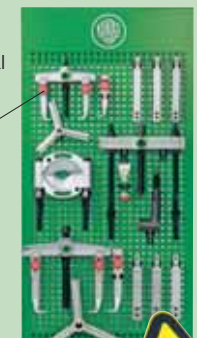

**Quick adjust**  
 TECHNOLOGY

Satz/Set/Jeu  
 16-teilig/parts  
 20-10+, 20-10-2+,  
 30-10+, 30-10-2+,  
 20-20+, 20-20-3+,  
 30-20+, 30-20-3+,  
 15-2, 9-1, 18-2,  
 699999

	EAN-Code	Art.-No.					Euro
	4021176-951114	WT-50	0-200	100-300	22-115	1	855,00





**WTH-000 Haken**  
hooks  
crochettes  
ganchos

WTH-01 - WTH-03



WTH-04 - WTH-06



WTH-07 - WTH-08



WTH-09 - WTH-11



ST	EAN-Code	Art.-No.			Euro
	4021176-				
	-890642	WTH-01	30 mm	1	4,60
	-890659	WTH-02	60 mm	1	4,60
	-890666	WTH-03	90 mm	1	4,60
	-890673	WTH-04	25 mm	1	4,60
	-890680	WTH-05	50 mm	1	4,60
	-890697	WTH-06	75 mm	1	4,60
	-890703	WTH-07	40 mm	1	7,60
	-890710	WTH-08	50 mm	1	7,60
	-890727	WTH-09	Ø 12 mm	1	4,20
	-890743	WTH-10	Ø 18 mm	1	4,20
	-890741	WTH-11	Ø 24 mm	1	4,20

**WW-01 Rollwerkbank**

Rolling workbench  
Etabli mobile  
Puesto de trabajo mobil  
Verrijdbare werkbank  
Posto di lavoro mobile



10 to  
**hydraulic**  
TECHNOLOGY

**Quick adjust**  
TECHNOLOGY

easyScrew  
TECHNOLOGY

LightSHIFT  
TECHNOLOGY



WW02mod-1



WW02mod-2



WW02mod-3

ST	EAN-Code	Art.-No.	Inhalt contents/contenu/inhoud		Euro
	4021176-				
	-923593	WW-01	leer / empty / vide	1	1776,00
	-924460	WW-02	WW-02-mod-1, WW-02-mod-2, WW-02-mod-3	1	6111,20
	-924576	WW02mod-1	zwei-, dreiarmige Abzieher	1	1440,70
	-924590	WW02mod-2	Trennen	1	1099,80
	-924613	WW02mod-3	Innenausziehen	1	1790,00
			Montagebügel für Lochplatten	1	auf Anfrage

**WW-66 KUKKO Werkstattwagen**

Workshop trolley  
Servante d'atelier  
Carro herramientas  
Gereedschapwagen  
Cassettiera mobile



passend für Hazet-Werkstattwagen

**Quick adjust**  
TECHNOLOGY



161-PE-U1



161-PE-A1



161-PE-A2



161-PE-U2



161-PE-67-1



161-PE-67-2

ST	EAN-Code	Art.-No.	Inhalt contents/contenu/inhoud		Euro
	4021176-				
	-963599	WW-66	161-PE-U1, 161-PE-A1, 161-PE-A2, 161-PE-U2, 161-PE-67-1, 161-PE-67-2	1	
	-961700	161-PE-U1		1	662,70
	-961687	161-PE-A1		1	1018,20
	-961694	161-PE-A2		1	770,80
	-961717	161-PE-U2		1	647,20
	-961663	161-PE-67-1		1	678,20
	-961670	161-PE-67-2		1	724,60

**T-AW-20 Mobiles Lager-Anwärmgerät**

Mobile inductive bearing heater  
Appareil mobile de réchauffage de roulements  
Calentador de rodamientos móvil inductivo  
Mobile lager inductie heater  
Sistema induttivo mobile per riscaldamento cuscinetti

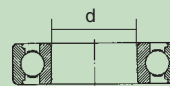

HY	EAN-Code	Art.-No.	Lager, bearings, roulements, cojinetes Ø d		Euro
	4021176-				
	-830976	T-AW-20	20 - 160 mm (max. 20kg)	1	3134,20

**T-AW-40 Stationäres Werkstatt-Anwärmgerät**

Workshop inductive bearing heater  
Appareil à poste fixe de réchauffage de roulements  
Calentador de rodamientos taller inductivo  
Werkplaats lager inductie heater  
Sistema induttivo stazionario per riscaldamento cuscinetti

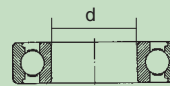

HY	EAN-Code	Art.-No.	Lager, bearings, roulements, cojinetes Ø d		Euro
	4021176-				
	-831133	T-AW-40	30 - 190 mm (max. 40 kg)	1	4477,50



# hydraulic

TECHNOLOGY

**Hydraulische Werkzeuge mit Pumpenantrieb**  
**Hydraulic pump-operated pulling and extracting tools**  
**Outilage hydraulique pour fonctionnement avec pompe**  
**Herramientas hidráulicas para funcionamiento de bombas**  
**Hydraulische gereedschappen voor gebruik met pomp**

**Y05 3-armige Abzieher**  
 3-arm pullers  
 Extracteurs à 3 bras  
 Extractores de 3 brazos  
 3-armige trekkers

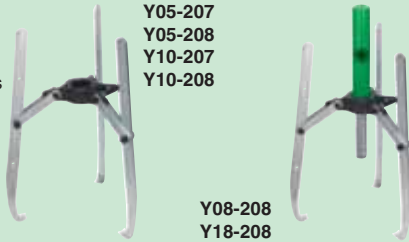

Y05-207  
 Y05-208  
 Y10-207  
 Y10-208

5 + 10 to  
**hydraulic**  
 TECHNOLOGY

Y08-208  
 Y18-208

81	EAN-Code	Art.-No.	mm	mm	to		Euro
HY	4021176-						
	-035586	Y05-207	250	215	5	1	220,40
	-172366	Y05-208	250	215	5	1	220,20
	-461774	Y08-208	250	215	5	1	673,60
	-035746	Y10-207	500	500	10	1	389,90
	-172441	Y10-208	500	500	10	1	550,20
	-461699	Y18-208	500	500	10	1	1127,80

**Y20-180 Hydraulische Abziehvorrichtungen**  
 Hydraulic push/pull devices  
 Dispositifs hydrauliques d'extraction  
 Dispositivos extractores hidráulicos  
 Hydraulische hulptrekkers

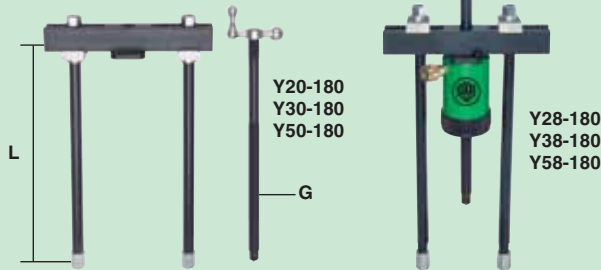

20 + 30 to  
**hydraulic**  
 TECHNOLOGY

86	EAN-Code	Art.-No.	mm	mm	to		Euro
HY	4021176-						
	-036323	Y20-180	135-300	300	20	1	616,40
	-036408	Y28-180	135-300	300	20	1	2161,10
	-039621	Y218-01	Zubehör/Accessories			1	6,30
	-076176	Y218-02				1	7,00
	-039706	Y218-03				1	324,40
	-039881	Y218-05				1	17,00
	-039966	Y218-06	L = 240 mm (1 Stück/piece/pièce)			1	54,30
	-040023	Y218-07	L = 420 mm (1 Stück/piece/pièce)			1	69,60
	-040108	Y218-08	L = 570 mm (1 Stück/piece/pièce)			1	88,20
	-040283	Y218-09				1	38,70
	-040368	Y218-10				1	29,50
	-040443	Y218-11	G = 1"-8 UNC			1	92,70
	-040511	Y218-12	L = 115 mm			1	46,40
	-040696	Y218-31				1	35,60
	-040771	Y218-33				1	69,60
	-037313	Y30-180	180-420	520	30	1	1027,40
	-037498	Y38-180	180-420	520	30	1	3012,40
	-041686	Y318-03	Zubehör/Accessories			1	441,90
	-041761	Y318-10				1	39,00
	-041846	Y318-11	G = 1 1/4"-7 UNC			1	324,40
	-041921	Y318-31				1	25,40
	-042003	Y318-32				1	22,40
	-042188	Y318-33				1	119,10
	-042263	Y318-35				1	27,40
	-042348	Y318-36	L = 205 mm (1 Stück/piece/pièce)			1	110,70
	-042423	Y318-37	L = 460 mm (1 Stück/piece/pièce)			1	154,20
	-042591	Y318-38	L = 710 mm (1 Stück/piece/pièce)			1	257,00
	-042676	Y318-39				1	85,60
	-042751	Y318-41				1	41,20

86	EAN-Code	Art.-No.	mm	mm	to		Euro
HY	4021176-						
	-038303	Y50-180	180-420	520	50	1	2610,70
	-038488	Y58-180	180-420	520	50	1	6171,10
	-043666	Y518-01	Zubehör/Accessories			1	31,00
	-043741	Y518-02				1	33,50
	-043826	Y518-03				1	1266,70
	-043901	Y518-07	L = 610 mm (1 Stück/piece/pièce)			1	363,10
	-044083	Y518-08	L = 865 mm (1 Stück/piece/pièce)			1	289,80
	-044168	Y518-09				1	191,50
	-044243	Y518-10				1	55,40
	-044328	Y518-11	G = 1 5/8"-5 1/2 UNS			1	448,00
	-044403	Y518-31	L = 460 mm (1 Stück/piece/pièce)			1	110,70
	-044571	Y518-33	L = 710 mm (1 Stück/piece/pièce)			1	176,60

## Y20-205 Hydraulische Abzieher

Hydraulic pullers  
 Extracteurs hydrauliques  
 Extractores hidráulicos  
 Hydraulische trekkers

20 + 30 + 50 to  
**hydraulic**  
 TECHNOLOGY

Y20-205  
 Y30-205  
 Y50-205

Y20-206  
 Y30-206  
 Y50-206

Y28-205  
 Y38-205  
 Y58-205

Y28-206  
 Y38-206  
 Y58-206

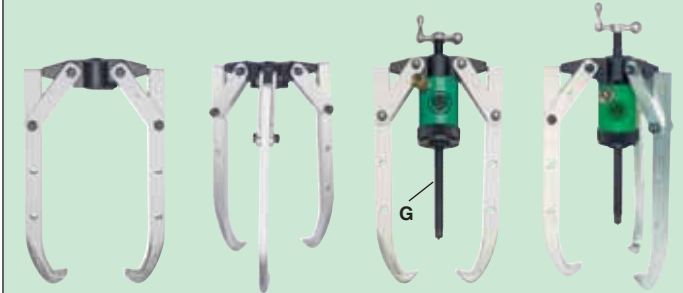

87	EAN-Code	Art.-No.	mm	mm	to		Euro
HY	4021176-						
	-035906	Y20-205	420	300	20	1	471,20
	-036163	Y20-206	500	300	20	1	733,80
	-036088	Y28-205	420	300	20	1	1543,20
	-036248	Y28-206	500	300	20	1	2008,20
	-273759	Y205-00	Zubehör/Accessories			1	157,40
	-038976	Y205-20				1	144,80
	-039058	Y205-21				1	40,20
	-039133	Y205-22				1	10,70
	-053306	Y205-23				1	2,60
	-039393	Y205-25				1	109,20
	-039478	Y206-30				1	386,30
	-036996	Y30-205	700	520	30	1	970,60
	-037153	Y30-206	900	520	30	1	1525,00
	-037078	Y38-205	700	520	30	1	2317,20
	-037238	Y38-206	900	520	30	1	3088,00
	-273834	Y305-00	Zubehör/Accessories			1	378,20
	-040931	Y305-20				1	214,80
	-041013	Y305-21				1	32,60
	-041198	Y305-22				1	6,20
	-143083	Y305-23				1	6,20
	-041358	Y305-25				1	301,00
	-041433	Y306-30				1	390,70
	-037986	Y50-205	1000	700	50	1	1820,30
	-038143	Y50-206	1200	700	50	1	2840,60
	-038068	Y58-205	1000	700	50	1	4680,70
	-038228	Y58-206	1200	700	50	1	5947,20
	-273919	Y505-00	Zubehör/Accessories			1	690,30
	-042911	Y505-20				1	440,30
	-043093	Y505-21				1	69,60
	-043178	Y505-22				1	14,60
	-143243	Y505-23				1	5,80
	-043338	Y505-25				1	538,20
	-043413	Y506-30				1	769,60





### Y28-200 Hydraulische Universal-Abzieh-Sätze

Hydraulic universal pulling and extracting sets  
 Jeux d'outillage d'extraction hydraulique, universel  
 Juegos de extracción universales hidráulicos  
 Hydraulische universele trekkersets

20 + 30 + 50to  
**hydraulic**  
 TECHNOLOGY



88	EAN-Code	Art.-No.	mm	mm	mm	to		Euro
	4021176-							
HY	-870828	Y28-200	500	300	25-155	20	1	5514,80
	-870835	Y38-300	900	520	30-250	30	1	7722,00
	-870842	Y58-500	1200	700	75-330	50	1	13130,00

### Y28-218 Hydraulische Abziehvorrichtungs-Sätze

Hydraulic push/pull device sets  
 Jeux de dispositifs hydrauliques d'extraction  
 Juegos de dispositivos extractores hidráulicos  
 Hydraulische hulptrekkersets

20 + 30 + 50to  
**hydraulic**  
 TECHNOLOGY



88	EAN-Code	Art.-No.	mm	mm	mm	to		Euro
	4021176-							
HY	-036651	Y28-218	140	30-180	25-155	20	1	3861,80
	-037641	Y38-318	150	75-230	30-250	30	1	5974,70
	-038891	Y58-518	150	75-230	75-330	50	1	9613,50

### Y28-256 Hydraulische Radabzieh-Sätze

Hydraulic wheel-puller sets  
 Jeux d'arrache-roues hydrauliques  
 Juegos de extractores hidráulicos de ruedas  
 Hydraulische wieltrek-sets

20 + 30 + 50to  
**hydraulic**  
 TECHNOLOGY



88	EAN-Code	Art.-No.	mm	mm	to		Euro
	4021176-						
HY	-036811	Y28-256	500	300	20	1	3152,70
	-037801	Y38-356	900	520	30	1	4541,80
	-038631	Y58-556	1200	700	50	1	7590,00

### Y-18-17 Druckstück Sätze für Achsbohrungen

Step plate adapter sets for center-bored parts  
 Embouts de pression de vis pour alésages axiaux  
 Piezas de presión de husillos para taladros de eje  
 Spindelstukken voor asboringen



55	EAN-Code	Art.-No.	Inhalt	Ø		Euro
	4021176-					
HY	-235078	Y-18-17	Y01 - Y11 12-teilig/parts	20 - 62	1	529,10
	-235153	Y-19-17	Y05 - Y16 12-teilig/parts	33 - 81	1	836,60
	-235238	Y-20-17	Y12 - Y17 6-teilig/parts	55 - 88	1	538,00
	-233173	Y-01-17	Einzel/individual/détachées	20 - 23	1	23,90
	-233258	Y-02-17	"	23 - 26	1	29,10
	-233333	Y-03-17	"	26 - 30	1	34,00
	-233418	Y-04-17	"	29 - 33	1	38,80
	-233586	Y-05-17	"	33 - 39	1	43,60
	-233661	Y-06-17	"	36 - 42	1	49,10
	-233746	Y-07-17	"	39 - 46	1	53,60
	-233821	Y-08-17	"	42 - 48	1	58,00
	-233906	Y-09-17	"	45 - 52	1	63,20
	-234163	Y-10-17	"	49 - 58	1	65,40
	-234248	Y-11-17	"	51 - 62	1	72,20
	-234408	Y-12-17	"	55 - 65	1	77,10
	-234576	Y-13-17	"	58 - 68	1	81,80
	-234651	Y-14-17	"	61 - 71	1	87,00
	-234736	Y-15-17	"	65 - 74	1	91,50
	-234811	Y-16-17	"	71 - 81	1	96,00
	-234996	Y-17-17	"	77 - 88	1	105,80

### Y-57 Hydraulische Mutternsprenger

Hydraulic nut splitters  
 Casse-écrous hydrauliques  
 Arrancatuercas hidráulicos  
 Hydraulische moerensplijters



Schwerlast Modelle für Pumpenbetrieb  
 Pump-driven heavy-duty models  
 pour fonctionnement avec pompe  
 para funcionamiento de bombas  
 heavy duty voor gebruik met pomp

63	EAN-Code	Art.-No.	SW mm	A.F."		Euro
	4021176-					
HY	-870675	Y-57-24	24-32	<sup>15</sup> / <sub>16</sub> - 1 <sup>1</sup> / <sub>4</sub>	1	2520,30
	-870682	Y-57-32	32-41	1 <sup>1</sup> / <sub>4</sub> - 1 <sup>5</sup> / <sub>8</sub>	1	3220,40
	-870699	Y-57-41	41-50	1 <sup>5</sup> / <sub>8</sub> - 2 <sup>1</sup> / <sub>16</sub>	1	4200,30
	-870705	Y-57-50	50-60	2 <sup>1</sup> / <sub>16</sub> - 2 <sup>3</sup> / <sub>8</sub>	1	6048,30
	-870712	Y-57-60	60-75	2 <sup>7</sup> / <sub>16</sub> - 3	1	10640,40
	-803741	Y-5724M	a) Zubehör/Accessories		1	179,00
	-803826	Y-5732M	a) Zubehör/Accessories		1	193,60
	-803901	Y-5741M	a) Zubehör/Accessories		1	213,50
	-804083	Y-5750M	a) Zubehör/Accessories		1	242,60
	-804168	Y-5760M	a) Zubehör/Accessories		1	415,20

### Y-215-2 Trennvorrichtungen

Separators  
 Décolleurs  
 Separadores  
 Mesttrekkers

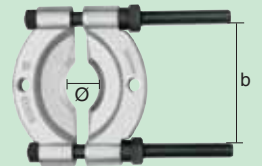

für hydraulische Abziehvrichtungen  
 for hydraulic push/pull devices  
 pour utilisation avec dispositifs hydrauliques  
 para uso con dispositivos extractores hidráulicos  
 voor gebruik met hydraulische hulptrekkers

86	EAN-Code	Art.-No.	Ø mm	b mm	to		Euro
	4021176-						
HY	-172106	Y-215-2	22-115	115	20	1	135,50
	-039546	Y-215-3	25-155	152	20	1	221,80
	-385629	Y-215-4	30-200	200	20	1	471,20
	-398186	Y-315-4	30-200	200	30	1	472,70
	-041501	Y-315-5	30-250	250	30	1	826,30
	-400063	Y-515-5	30-250	250	50	1	873,10
	-043581	Y-515-6	75-330	330	50	1	2019,90
	-172281	Y-515-7	80-420	420	50	1	4180,80



### Einzelteile/Individual parts/Pièces détachées



90	EAN-Code	Art.-No.	für/for/pour/para/voor		Euro
HY	4021176-				
	-145971	Y15-600	Y-515-6	1	804,70
	-177316	Y15-700	Y-515-7	1	1878,20

### Y221-E Innenauszieher

Internal extractors  
Extracteurs intérieurs  
Extractores interiores  
Binnentrekkers



Y221-E



Y321-E

Y521-E

86	EAN-Code	Art.-No.		mm		mm	to		Euro
HY	4021176-								
	-040856	Y-221-E		140		30-180	20	1	307,50
	-042836	Y-321-E		150		75-230	30	1	554,20
	-044656	Y-521-E		150		75-230	50	1	602,60

### YCH-604 Schnellkupplungen

High-flow couplings  
Raccords  
Acoplamientos  
Snelkoppelingen



YCH-604



YCR-400

90	EAN-Code	Art.-No.	für/for/pour/para/voor		Euro
HY	4021176-				
	-440731	YCH-604	Schlauch/Hose/Tuyau/ Tubo/Slang	1	72,20
	-201318	YCR-400	Zylinder/Ram/Vérin/Cilindro	1	108,70

### YDB Druckstücke für Hohlkolbenzylinder

Pressure pads for hollow rams  
Embouts de pression pour vérins à piston creux  
Piezas de presión para cilindros de émbolo hueco  
Drukstukken voor cylinders met holle plunjer

YDB



YDG



YDM



90	EAN-Code	Art.-No.	für/for/pour/para/voor		Euro
HY	4021176-				
	-400223	YDB-27E	20 to	1	61,10
	-400308	YDB-33E	30 to	1	62,60
	-400483	YDB-55E	50 to	1	77,40
	-399091	YDG-20E	20 to	1	64,40
	-399176	YDG-30E	30 to	1	66,60
	-399251	YDG-50E	50 to	1	103,10
	-414183	YDM-20E	20 to	1	65,20
	-414268	YDM-30E	30 to	1	70,70
	-414343	YDM-50E	50 to	1	109,20

### YHP Hydraulik Handpumpe, Manometer und Schlauch

Hydraulic hand pump, gauge and hoses  
Pompe à main hydraulique, tuyau flexible et manomètre  
Bomba manuale, tubo flessibile y manómetro  
Hydraulische handpomp, manometer en slang

**NEU-NEW**

**5+10+20+30 to**  
**hydraulic**  
TECHNOLOGY



YHP-310 + YM-235



YHP-320



YHP-326



YM-235



YF-200

YHP-310	Pumpe/pump/pompe
YHP-320	Pumpe/pump/pompe
YHP-321	= YHP-320 + YF-200
YHP-324	= YHP-320 + YM-235
YHP-325	= YHP-320 + YF-200 + YM-235
YHP-326	= YHP-325 + Kasten / Case / Coffret
YF-200	2 m Schlauch / Hose / Tuyau
YM-235	700 bar Manometer / Gauge / Manomètre
YGA-2	Adapter/Adaptateur

HY	EAN-Code	Art.-No.	bar	oil cm <sup>3</sup>	Hub stroke		Euro
	-139550	YHP-310	700	500	23	1	613,00
	-045721	YHP-320	700	900	23	1	443,00
	-111198	YHP-321	700	900	23	1	637,50
	-045806	YHP-324	700	900	23	1	712,70
	-045981	YHP-325	700	900	23	1	918,70
	-046483	YHP-326	700	900	23	1	1063,10
	-045646	YF-200	2 m Schlauch / Hose / Tuyau			1	206,60
	-157769	YM-235	700 bar Manometer / Gauge / Manomètre			1	269,50
	-458644	YGA-2	Adapter/Adaptateur			1	84,00

Modell bestellen unter:  
Z-LKW-06-1 PG2





### YRE Hydraulische Druckzylinder mit Krallengewinde

Hydraulic cylinder rams with collar threads  
Vérins hydrauliques à collet fileté  
Cilindros de presión hidráulicos con rosca de collarín  
Hydraulische drukcilinders met buitendraad

**NEU-NEW**

**5 + 10 to**  
**hydraulic**  
TECHNOLOGY



90	EAN-Code	Art.-No.	to/kN	Hub/stroke/course		Euro
HY	4021176-046551	YRE-050	5/50	125	1	450,40
	-870927	YRE-101	10/100	250	1	692,20
	-879401	YRE-102	10/100	100	1	1053,00

### YRH Hydraulische Hohlkolbenzylinder

Hydraulic hollow rams  
Vérins hydrauliques à piston creux  
Cilindros hidráulicos de émbolo hueco  
Hydraulische holle plunjer cylinders

YDG

YRH-202  
YRH-206  
YRH-302  
YRH-603



**20 + 30 + 50 to**  
**hydraulic**  
TECHNOLOGY

90	EAN-Code	Art.-No.	to/kN	Hub/stroke/course		Euro
HY	4021176-046711	YRH-202	20/200	50	1	938,30
	-870934	YRH-206	20/200	150	1	1610,20
	-046896	YRH-302	30/300	63	1	1036,00
	-046971	YRH-603	50/500	75	1	2198,20
	-399336	YP-2013	YRH-202 + YRH-206		1	14,20
	-461859	YP-3013	YRH-302		1	21,40
	-399411	YP-5013	YRH-603		1	28,20

### YRH-9 Hydr. Zusatzpresse

Auxiliary hydr. ram  
Presse hydr. auxiliaire  
Prensa hidr. auxiliar  
Hydraulische hülppersen



**10 to**  
**hydraulic**  
TECHNOLOGY

90	EAN-Code	Art.-No.	Hub/stroke/course	to/KN		Euro
HY	4021176-800306	YRH-9	30 mm	10/100	1	2646,00



### GOLIATH Mobiler Hydraulik-Abzieher

Mobile hydraulic puller  
Mobile hydraulique extracteur  
Móvil hidráulica extractores  
Mobeile hydraulische trekker

**60 to**

**hydraulic**  
TECHNOLOGY

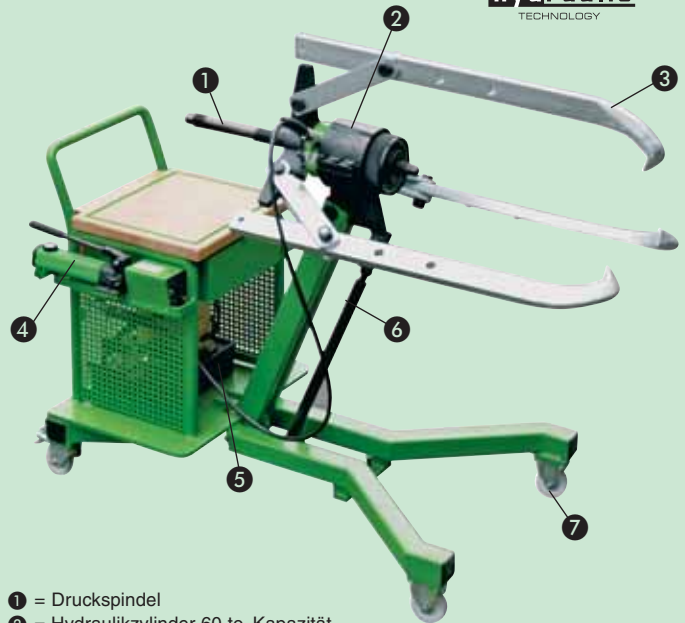

- 1 = Druckspindel
- 2 = Hydraulikzylinder 60 to. Kapazität
- 3 = Abzieharme Spannweite: 1000 mm
- 4 = Hydraulische Handpumpe zur Höhenverstellung
- 5 = Elektrische Hydraulikpumpe für den 60 to. Zylinder
- 6 = Höhenverstellbar (0,40 - 1,20m)
- 7 = Zwei Bock- und Lenkrollen mit Feststellmöglichkeit

90	EAN-Code	Art.-No.		mm		mm		Euro
HY	4021176-978326	GOLIATH		1000		700	1	15111,40

### GOLIATH Mobile Hydraulik-Trennvorrichtung

Mobile hydraulic separator  
Mobile hydraulique décolleurs  
Móvil hidráulica separadores  
Mobeile hydraulische mestrekkers

**50 to**

**hydraulic**  
TECHNOLOGY



- 1 = Handrad z. Voreinstellen der Spannweite
- 2 = Hydraulikzylinder 50 to. Kapazität
- 3 = Trennmesser Ø 75 - 330 mm
- 4 = Hydraulische Handpumpe zur Höhenverstellung
- 5 = Elektrische Hydraulikpumpe für den 50 to. Zylinder
- 6 = Höhenverstellbar (0,40 - 1,20m)
- 7 = Zwei Bock- und Lenkrollen mit Feststellmöglichkeit

90	EAN-Code	Art.-No.	Ø	mm	mm		Euro
HY	4021176-995057	GOLIATH-2		75-330	80-400	1	16192,60



# STAR FLEX

## Ultrahelle AKKU-Werkstattlampe No. Z153

- Multifunktional als Taschenlampe und Arbeitslampe
- Kompaktes Design auch für schwer zugängliche Stellen



120°  
schwenkbarer  
LED-Strahler

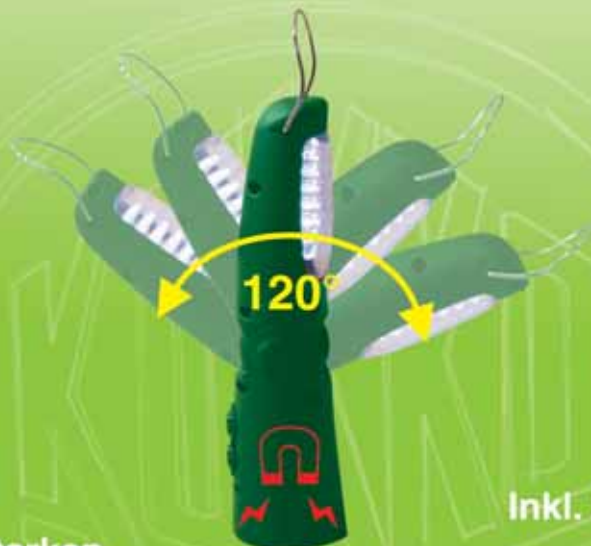

Universelle  
Befestigung durch  
eingebauten sehr starken  
Magneten.

**52,00 Euro**

Inkl. 230 V AV Ladegerät  
Ladezeit: 3 Std.  
Stromversorgung: NiMH-Akku 3,6 V



1007-S-12-T



- SW 19
- SW 21 MS
- SW 22
- SW 24



### 133 Schlag-Maulschlüssel (DIN 133)

Open-end slogging spanners  
Clés à fourche à frapper  
Llaves fija de golpe  
Steekslagsleutels  
Chiavi a forchetta a percussione



64	EAN-Code	Art.-No.	mm		Euro
ST	4021176-				
	-865213	133-24	24	1	16,70
	-854804	133-27	27	1	18,70
	-854989	133-30	30	1	19,80
	-855061	133-32	32	1	20,40
	-904394	133-34	34	1	27,50
	-855146	133-36	36	1	23,80
	-855221	133-41	41	1	31,50
	-855306	133-46	46	1	38,30
	-855481	133-50	50	1	44,40
	-855559	133-55	55	1	55,20
	-855634	133-60	60	1	59,50
	-855719	133-65	65	1	74,70
	-855894	133-70	70	1	94,60
	-855979	133-75	75	1	104,00
	-856051	133-80	80	1	126,50
	-856136	133-85	85	1	136,50
	-856211	133-90	90	1	188,00
	856396	133-95	95	1	196,00
	-856471	133-100	100	1	374,00
	-865176	133-105	105	1	441,00
	-865183	133-110	110	1	452,00
	-865190	133-115	115	1	604,00
	-865206	133-120	120	1	628,00

### 406 Schlag-Ringschlüssel (DIN 7444)

Slogging spanners  
Clés polygones à frapper  
Llaves poligonal de golpe  
Ringslagsleutels  
Chiavi poligonal a percussione



64	EAN-Code	Art.-No.	mm		Euro
ST	4021176-				
	-856549	406-24	24	1	15,60
	-856624	406-27	27	1	19,00
	-856709	406-30	30	1	22,30
	-856884	406-32	32	1	24,00
	-904431	406-34	34	1	30,70
	-856969	406-36	36	1	29,50
	-857041	406-41	41	1	38,60
	-857126	406-46	46	1	41,20
	-857201	406-50	50	1	48,00
	-857386	406-55	55	1	53,40
	-857461	406-60	60	1	57,50
	-857539	406-65	65	1	75,00
	-857614	406-70	70	1	82,70
	-857799	406-75	75	1	89,50
	-857874	406-80	80	1	126,60
	-857959	406-85	85	1	154,00
	-858031	406-90	90	1	189,00
	-858116	406-95	95	1	213,50
	-858291	406-100	100	1	239,00
	-858376	406-105	105	1	331,00
	-858451	406-110	110	1	357,00
	-858529	406-115	115	1	391,00
	-858604	406-120	120	1	855,00

### 402 Zug-Ringschlüssel

Heavy duty ring spanners  
Clés polygones à manche adaptable  
Llaves de golpe, estrella luneta  
Opsteekringsleutels  
Chiavi poligonal teste inclinate



64	EAN-Code	Art.-No.	mm		Euro
ST	4021176-				
	963858	402-24	24	1	33,10
	963865	402-27	27	1	49,10
	963872	402-30	30	1	37,00
	963889	402-32	32	1	53,20
	963896	402-36	36	1	81,90
	963902	402-41	41	1	58,00
	963919	402-46	46	1	67,60
	963933	402-50	50	1	78,80
	963940	402-55	55	1	85,80
	963957	402-60	60	1	111,60
	963971	402-65	65	1	126,30
	963988	402-70	70	1	139,60
	963995	402-75	75	1	147,80
	964015	402-80	80	1	198,60

### 402 Aufsteckrohre

Spanner extensions  
Rallonges  
Cabos extensivel  
Pijpgrepen  
Leve di manovra



64	EAN-Code	Art.-No.	L mm	für for/pour/para		Euro
ST	4021176-					
	963926	402-460	460	402-24, -27, -30	1	21,00
	963964	402-610	610	402-32, -36, -41	1	24,30
	964008	402-760	760	402-46, -50, -55	1	47,40
	964022	402-860	860	402-60, -65, -70, -75, -80	1	65,20

### 407-A Engraum Kombischlüssel Satz

Tight-space wrench set  
Clés pour espace réduit, jeu  
Juego de llaves de tornillos para espacios angostos  
Set combi-sleutels voor nauwe tussenruimtes  
Serie Chiavi per spazi ristretti



60	EAN-Code	Art.-No.	10-teilig/10-parts Satz/Set/Jeu		Euro
ST	-865978	407-A	10-11-12-13-14-15-16-17-18-19 mm	1	106,80

### 408 Schlag-Ringschlüssel - Zoll/inches (DIN 7444)

Slogging spanners  
Clés polygones à frapper  
Llaves poligonal de golpe  
Ringslagsleutels  
Chiavi poligonal a percussione



64	EAN-Code	Art.-No.	Zoll/inches/pollici		Euro
ST	4021176-				
	-893704	408-27	1. 1/16"	1	19,80
	-893711	408-30	1. 3/16"	1	20,00
	-964039	408-32	1. 1/4"	1	63,90
	-893728	408-35	1. 3/ 8"	1	26,70
	-964046	408-38	1. 1/2"	1	27,40
	-964053	408-41	1. 5/8"	1	39,90
	-893735	408-42	1.11/16"	1	39,90
	-893742	408-46	1.13/16"	1	46,80
	-893759	408-47	1. 7/ 8"	1	47,10
	-893766	408-50	2"	1	55,90
	-893773	408-54	2. 1/ 8"	1	75,50
	-893780	408-55	2. 3/16"	1	73,10
	-893797	408-58	2. 1/ 4"	1	73,40
	-893803	408-65	2. 9/16"	1	93,20
	-893810	408-68	2. 5/ 8"	1	93,80
	-893827	408-70	2. 3/ 4"	1	101,00
	-893834	408-75	3"	1	107,00
	-893841	408-80	3. 1/ 8"	1	148,60

**1002 Doppel-Ringschlüssel, tief gekröpft (DIN 838)**

Double ended ring spanners, deep offset  
 Cles polygonales contre-coudées  
 Llaves luneta  
 Dubbele ringsleutels, diep doorgezet  
 Chiavi poligonali doppie, teste inclinate



ST	EAN-Code 4021176-	Art.-No.	mm		Euro
	963605	1002-06x07	6 x 7	10	42,40
	964398	1002-08x09	8 x 9	10	35,10
	964404	1002-10x11	10 x 11	10	37,90
	964411	1002-12x13	12 x 13	10	44,80
	964428	1002-12x14	12 x 14	10	80,80
	964435	1002-13x15	13 x 15	10	93,10
	964442	1002-14x15	14 x 15	10	57,50
	964459	1002-16x17	16 x 17	10	71,40
	964466	1002-17x19	17 x 19	10	90,70
	964473	1002-18x19	18 x 19	10	93,20
	964480	1002-19x22	19 x 22	10	100,00
	964497	1002-20x22	20 x 22	10	113,40
	964503	1002-21x23	21 x 23	10	110,00
	968334	1002-22x24	22 x 24	10	133,10
	968341	1002-24x26	24 x 26	5	66,60
	968358	1002-24x27	24 x 27	5	86,70
	266058	1002-24x30	24 x 30	5	82,70
	968365	1002-25x28	25 x 28	5	82,70
	968372	1002-27x30	27 x 30	5	98,70
	968389	1002-27x32	27 x 32	5	110,00
	968396	1002-30x32	30 x 32	5	93,10
	968402	1002-30x34	30 x 34	5	117,60
	968419	1002-36x41	36 x 41	5	188,30
<b>/INCHES/POLLICI</b>					
	968471	1002-Z-06	1/4 x 5/16"	10	39,20
	968488	1002-Z-09	3/8 x 7/16"	10	42,00
	968495	1002-Z-12	1/2 x 9/16"	10	57,50
	968501	1002-Z-15	5/8 x 11/16"	10	70,00
	968518	1002-Z-16	5/8 x 3/4"	10	100,20
	968525	1002-Z-20	13/16 x 7/8"	10	96,70
	968532	1002-Z-22	15/16 x 1"	10	138,70
	968549	1002-Z-26	1.1/16 x 1.1/4"	10	232,40

**1002 Doppel-Ringschlüssel, tief gekröpft (DIN 838)**

Double ended ring spanners, deep offset  
 Cles polygonales contre-coudées  
 Llaves luneta  
 Dubbele ringsleutels, diep doorgezet  
 Chiavi poligonali doppie, teste inclinate

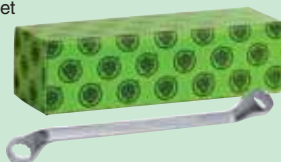

ST	EAN-Code 4021176-	Art.-No.	Sätze/Sets/Jeux/Juegos			Euro
	968426	1002-S-08	6 - 22 mm	8 tlg./parts	1	44,00
	968433	1002-S-10	6 - 32 mm	10 tlg./parts	1	75,80
	968440	1002-S-12	6 - 32 mm	12 tlg./parts	1	102,70
	968457	1002-S-13	6 - 41 mm	13 tlg./parts	1	140,20
	983214	1006-SA-10	6 - 26 mm	10 tlg./parts	1	69,20
	983221	1006-SA-12	6 - 32 mm	12 tlg./parts	1	103,10
	968464	1002-SZ-08	1/4" - 1.1/4"	8 tlg./parts	1	120,00

**1002 Doppel-Ringschlüssel, tief gekröpft (DIN 838) in Rolltasche**

Double ended ring spanners, deep offset  
 Cles polygonales contre-coudées  
 Llaves luneta  
 Dubbele ringsleutels, diep doorgezet  
 Chiavi poligonali doppie, teste inclinate



ST	EAN-Code 4021176-	Art.-No.	Sätze/Sets/Jeux/Juegos			Euro
	304583	1002-S-08-T	6 - 22	8 tlg./parts	1	54,30
	304590	1002-S-10-T	6 - 32	10 tlg./parts	1	87,90
	304613	1002-S-12-T	6 - 32	12 tlg./parts	1	116,30

**1004 Doppel-Ringschlüssel, gerade (DIN 837 B)**

Double ended ring spanners, straight  
 Cles polygonales, droites  
 Llaves estrela planas  
 Dubbele ringsleutels, plat  
 Chiavi poligonali doppie, dritte



ST	EAN-Code 4021176-	Art.-No.	mm		Euro
	968556	1004-06x07	6 x 7	10	33,40
	968563	1004-08x09	8 x 9	10	33,60
	968570	1004-10x11	10 x 11	10	33,60
	968587	1004-12x13	12 x 13	10	37,90
	968594	1004-14x15	14 x 15	10	46,30
	968600	1004-16x17	16 x 17	10	50,40
	968617	1004-18x19	18 x 19	10	51,90
	968624	1004-20x22	20 x 22	10	70,00

**1004 Doppel-Ringschlüssel, gerade (DIN 837 B)**

Double ended ring spanners, straight  
 Cles polygonales, droites  
 Llaves estrela planas  
 Dubbele ringsleutels, plat  
 Chiavi poligonali doppie, dritte



ST	EAN-Code 4021176-	Art.-No.	Sätze/Sets/Jeux/Juegos			Euro
	968631	1004-S-08	6 - 22 mm	8 tlg./parts	1	35,40

**1006 Doppel-Maulschlüssel (DIN 3110)**

Double ended open jaw spanners  
 Cles a fourche double  
 Llaves fixas duas bocas  
 Dubbele steeksleutels  
 Chiavi a doppia forchetta



ST	EAN-Code 4021176-	Art.-No.	mm		Euro
	968648	1006-06x07	6 x 7	10	32,30
	968655	1006-07x08	7 x 8	10	32,20
	968662	1006-08x09	8 x 9	10	32,30
	968679	1006-08x10	8 x 10	10	30,40
	968686	1006-10x11	10 x 11	10	23,90
	968693	1006-10x12	10 x 12	10	38,40
	968709	1006-10x13	10 x 13	10	29,50
	968716	1006-12x13	12 x 13	10	34,40
	968723	1006-12x14	12 x 14	10	34,40
	968730	1006-13x14	13 x 14	10	35,10
	968747	1006-13x17	13 x 17	10	51,60
	968754	1006-14x15	14 x 15	10	50,60
	968761	1006-14x17	14 x 17	10	44,80
	968778	1006-16x17	16 x 17	10	44,80
	968785	1006-17x19	17 x 19	10	49,10
	968792	1006-18x19	18 x 19	10	49,10
	968808	1006-19x22	19 x 22	10	62,20
	968815	1006-20x22	20 x 22	10	54,70
	968822	1006-21x23	21 x 23	10	57,50
	968839	1006-21x24	21 x 24	10	57,50
	968846	1006-22x24	22 x 24	10	64,40
	968853	1006-24x26	24 x 26	10	68,70
	968860	1006-24x27	24 x 27	10	68,70
	266126	1006-24x30	24 x 30	10	95,20
	968877	1006-25x28	25 x 28	10	97,00
	968884	1006-27x29	27 x 29	10	109,20
	968891	1006-27x30	27 x 30	10	109,20
	968907	1006-27x32	27 x 32	10	109,20
	968914	1006-30x32	30 x 32	10	113,90
	968921	1006-30x34	30 x 34	5	67,60
	968938	1006-30x36	30 x 36	5	67,20
	968945	1006-32x36	32 x 36	5	94,60
	968952	1006-36x41	36 x 41	5	116,30



**1006 Doppel-Maulschlüssel (DIN 3110)**  
 Double ended open jaw spanners  
 Cles a fourche double  
 Llaves fixas duas bocas  
 Dubbele steeksleutels  
 Chiavi a doppia forchetta



EAN-Code	Art.-No.	Zoll / Inches / Pollici		Euro
969010	1006-Z-09	3/8" x 7/16"	10	26,70
969027	1006-Z-12	1/2" x 9/16"	10	36,40
969034	1006-Z-15	19/32" x 11/16"	10	47,60
969041	1006-Z-16	5/8" x 3/4"	10	56,40
969058	1006-Z-20	13/16" x 7/8"	10	63,10
969065	1006-Z-23	15/16" x 1"	10	77,10

**1006 Doppel-Maulschlüssel (DIN 3110)**  
 Double ended open jaw spanners  
 Cles a fourche double  
 Llaves fixas duas bocas  
 Dubbele steeksleutels  
 Chiavi a doppia forchetta



EAN-Code	Art.-No.	Sätze/Sets/Jeux/Juegos			Euro
968969	1006-S-08	6 - 22 mm	8 tlg./parts	1	31,90
968976	1006-S-10	6 - 32 mm	10 tlg./parts	1	45,20
968983	1006-S-12	6 - 32 mm	12 tlg./parts	1	62,20
968990	1006-S-13	6 - 41 mm	13 tlg./parts	1	83,90
983238	1006-SA-10	6 - 26 mm	10 tlg./parts	1	40,00
983245	1006-SA-12	6 - 32 mm	12 tlg./parts	1	60,70
983252	1006-SA-13	6 - 32 mm	13 tlg./parts	1	71,50
969003	1006-SZ-06	3/8" - 1"	6 tlg./parts	1	29,60

**1006 Doppel-Maulschlüssel in Rolltasche (DIN 3110)**  
 Double ended open jaw spanners  
 Cles a fourche double  
 Llaves fixas duas bocas  
 Dubbele steeksleutels  
 Chiavi a doppia forchetta



EAN-Code	Art.-No.	Sätze/Sets/Jeux/Juegos			Euro
304668	1006-S-08-T	6 - 22	8 tlg./parts	1	36,70
304675	1006-S-10-T	6 - 32	10 tlg./parts	1	56,40
304682	1006-S-12-T	6 - 32	12 tlg./parts	1	78,60

**1007 Ring-Maulschlüssel DIN 3113, Form A, ISO 7738**  
 Combination Spanners  
 Cles mixtes  
 Llaves combinadas  
 Steekringsleutels  
 Chiavi combinate a forchetta e poligonali



EAN-Code	Art.-No.	mm		Euro
969072	1007-05	5,5	10	23,80
969089	1007-06	6	10	19,60
969096	1007-07	7	10	21,10
969102	1007-08	8	10	22,00
969119	1007-09	9	10	25,40
969126	1007-10	10	10	27,10
969133	1007-11	11	10	26,70
969140	1007-12	12	10	38,60
969157	1007-13	13	10	32,30
969164	1007-14	14	10	36,40
969171	1007-15	15	10	38,70
969188	1007-16	16	10	42,00
969195	1007-17	17	10	46,70
969201	1007-18	18	10	50,40

EAN-Code	Art.-No.	mm		Euro
969218	1007-19	19	10	54,70
969225	1007-20	20	10	57,50
969232	1007-21	21	10	64,80
969249	1007-22	22	10	65,90
969256	1007-23	23	5	42,70
969263	1007-24	24	5	44,20
969270	1007-25	25	5	51,10
969287	1007-26	26	5	52,60
969294	1007-27	27	5	58,20
969300	1007-28	28	5	60,30
969317	1007-29	29	5	68,80
969324	1007-30	30	5	69,40
969331	1007-32	32	5	77,80
983269	1007-34	34	5	104,30
969348	1007-36	36	5	104,30
983283	1007-38	38	5	159,00
969355	1007-41	41	5	139,40

**1007 Ring-Maulschlüssel (DIN 3113)**  
 Combination Spanners  
 Cles mixtes  
 Llaves combinadas  
 Steekringsleutels  
 Chiavi combinate a forchetta e poligonali



EAN-Code	Art.-No.	Zoll / Inches / Pollici		Euro
965326	1007-Z-06	1/4"	10	35,50
965340	1007-Z-08	5/16"	10	44,00
965364	1007-Z-09	3/8"	10	45,90
965388	1007-Z-11	7/16"	10	48,70
965401	1007-Z-12	1/2"	10	50,20
965425	1007-Z-14	9/16"	10	47,50
965449	1007-Z-16	5/8"	10	50,40
965463	1007-Z-17	11/16"	10	58,80
970238	1007-Z-19	3/4"	10	74,30
970252	1007-Z-20	13/16"	10	77,10
970276	1007-Z-22	7/8"	10	84,00
970290	1007-Z-23	15/16"	10	101,40
970313	1007-Z-25	1"	10	116,30
970337	1007-Z-26	1.1/16"	10	123,20
970351	1007-Z-28	1.1/8"	10	147,10
970375	1007-Z-32	1.1/4"	10	166,70

**1007 Ring-Maulschlüssel (DIN 3113)**  
 Combination Spanners  
 Cles mixtes  
 Llaves combinadas  
 Steekringsleutels  
 Chiavi combinate a forchetta e poligonali

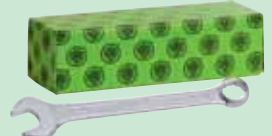

EAN-Code	Art.-No.	Sätze/Sets/Jeux/Juegos			Euro
983306	1007-S-08	8 - 22 mm	8 tlg./parts	1	34,60
969362	1007-S-09	6 - 19 mm	9 tlg./parts	1	31,10
969379	1007-S-12	6 - 24 mm	12 tlg./parts	1	52,30
969386	1007-S-15	6 - 32 mm	15 tlg./parts	1	93,80
975707	1007-S-17	6 - 22 mm	17 tlg./parts	1	64,70
969393	1007-S-19	5,5 - 24 mm	19 tlg./parts	1	75,40
969409	1007-S-26	6 - 32 mm	26 tlg./parts	1	168,80
970221	1007-SZ-12	1/4" - 1.1/4"	12 tlg./parts	1	104,80

**1007 Ring-Maulschlüssel in Rolltasche**  
 Combination Spanners  
 Cles mixtes  
 Llaves combinadas  
 Steekringsleutels  
 Chiavi combinate a forchetta e poligonali



EAN-Code	Art.-No.	Sätze/Sets/Jeux/Juegos			Euro
304729	1007-S-09-T	6 - 19	9 tlg./parts	1	70,00
309908	1007-S-12-T	6 - 24	12 tlg./parts	1	80,00
319990	1007-S-15-T	6 - 32	15 tlg./parts	1	106,80





### 1895 Doppel-Maulschlüssel (DIN 895)

Double ended open jaw spanners  
Cles a fourche double  
Llaves fixas duas bocas  
Dubbele steeksleutels  
Chiavi a doppia forchetta



ST	EAN-Code 4021176-	Art.-No.	mm		Euro
	965791	1895-36x41	36x41	1	14,40
	965807	1895-41x46	41x46	1	19,80
	965814	1895-46x50	46x50	1	25,50
	965821	1895-50x55	50x55	1	33,10
	965838	1895-55x60	55x60	1	39,80

### 1896 Doppel-Steckschlüssel (DIN 896-B)

Double Ended Socket Wrenches  
Cles en tube droites  
Llaves de tubo  
Dubbele pijpsleutels  
Chiavi a tubo doppie



ST	EAN-Code 4021176-	Art.-No.	mm		Euro
	969560	1896-06x07	6 x 7	10	42,00
	969584	1896-08x09	8 x 9	10	42,00
	969607	1896-10x11	10 x 11	10	46,30
	969621	1896-12x13	12 x 13	10	53,20
	969645	1896-13x15	13 x 15	10	58,40
	969669	1896-14x15	14 x 15	10	57,50
	969683	1896-16x17	16 x 17	10	75,60
	969706	1896-18x19	18 x 19	10	79,90
	969720	1896-20x22	20 x 22	10	86,80
	969744	1896-21x23	21 x 23	5	44,20
	969768	1896-24x26	24 x 26	5	65,10
	969782	1896-24x27	24 x 27	5	66,60
	969805	1896-25x28	25 x 28	5	72,20
	969829	1896-27x32	27 x 32	5	73,50

### 1896 Universal Drehstift

Universal tommy bar  
Broche a reduction univ.  
Perno passante univers.  
Universele draaistift  
Spina di manovra univers.



ST	EAN-Code 4021176-	Art.-No.	L mm	Ø		Euro
	969843	1896-57	185	6 + 8 + 10 + 12 mm	10	80,00

### 1896 Doppel-Steckschlüssel (DIN 896-B)

Double Ended Socket Wrenches  
Cles en tube droites  
Llaves de tubo  
Dubbele pijpsleutels  
Chiavi a tubo doppie



ST	EAN-Code 4021176-	Art.-No.	Sätze/Sets/Jeux/Juegos			Euro
	969867	1896-S-08	6 – 22 mm	8 tlg./parts	1	47,40
	969874	1896-S-12	6 – 32 mm	12 tlg./parts	1	98,20

### 2000 Sechskant-Gelenkschlüssel mit T-griff

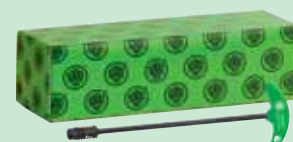

ST	EAN-Code 4021176-	Art.-No.	Sätze/Sets/Jeux/Juegos		Euro	
	510137	2000-A	7 – 13 mm	7 tlg./parts	1	197,50

### 2000 Sechskant-Gelenkschlüssel mit T-griff



ST	EAN-Code 4021176-	Art.-No.	mm		Euro
	510012	2000-07	7	1	34,70
	510021	2000-08	8	1	34,70
	510045	2000-09	9	1	34,70
	510052	2000-10	10	1	34,70
	510069	2000-11	11	1	34,70
	510076	2000-12	12	1	34,70
	510083	2000-13	13	1	34,70

### 2001 Sechskant-Gelenkschlüssel mit T-griff



ST	EAN-Code 4021176-	Art.-No.	Zoll / inches / pollici		Euro
	510090	2001-01	1/4"	1	50,40

### Preis Gruppen D

Price categories  
Catégories de prix  
Categorías de precios  
Prijis categoriën

### Ersatzteile

Spare parts  
Pieces de rechange  
Piezas de recambio  
Onderdelen

Kategorie		EURO
PG 0	1	7,00
PG 1	1	10,00
PG 2	1	30,00
PG 3	1	40,00
PG 4	1	60,00
PG 5	1	80,00
PG 6	1	110,00
PG 7	1	150,00
PG 8	1	190,00
PG 9	1	230,00
PG 10	1	370,00
PG 11	1	500,00
PG 12	1	840,00

### Preisliste, Price list, Tarif, Prijslijst W-409

Alle früheren Preislisten verlieren mit dieser Liste ihre Gültigkeit. Dieser Preisliste liegen unsere allgemeinen Geschäftsbedingungen zugrunde. Maße und Gewichte sind nur annähernd. Modell- und Ausführungsänderungen, Irrtümer und Druckfehler behalten wir uns vor.

Our general terms of business form the basis of this Price List. Measurements and weights are only approximate. All rights are reserved for alteration of models and finishes, mistakes and misprint.

Ce tarif est basé sur les conditions générales de vente de notre maison. Les dimensions et poids mentionnés ne sont qu'approximatifs. Nous nous réservons le droit de modifier le modèles et exécutions, sauf erreur.

Hiermede vervallen alle voorgaande prijslijsten. Op deze prijslijst zijn onze algemene verkoopvoorwaarden van toepassing. Afmetingen en gewichten zijn slechts indicaties. Wijzigingen in model of uitvoering, drukfouten en vergissingen onder voorbehoud.

# KUKKO-Poster-Collection



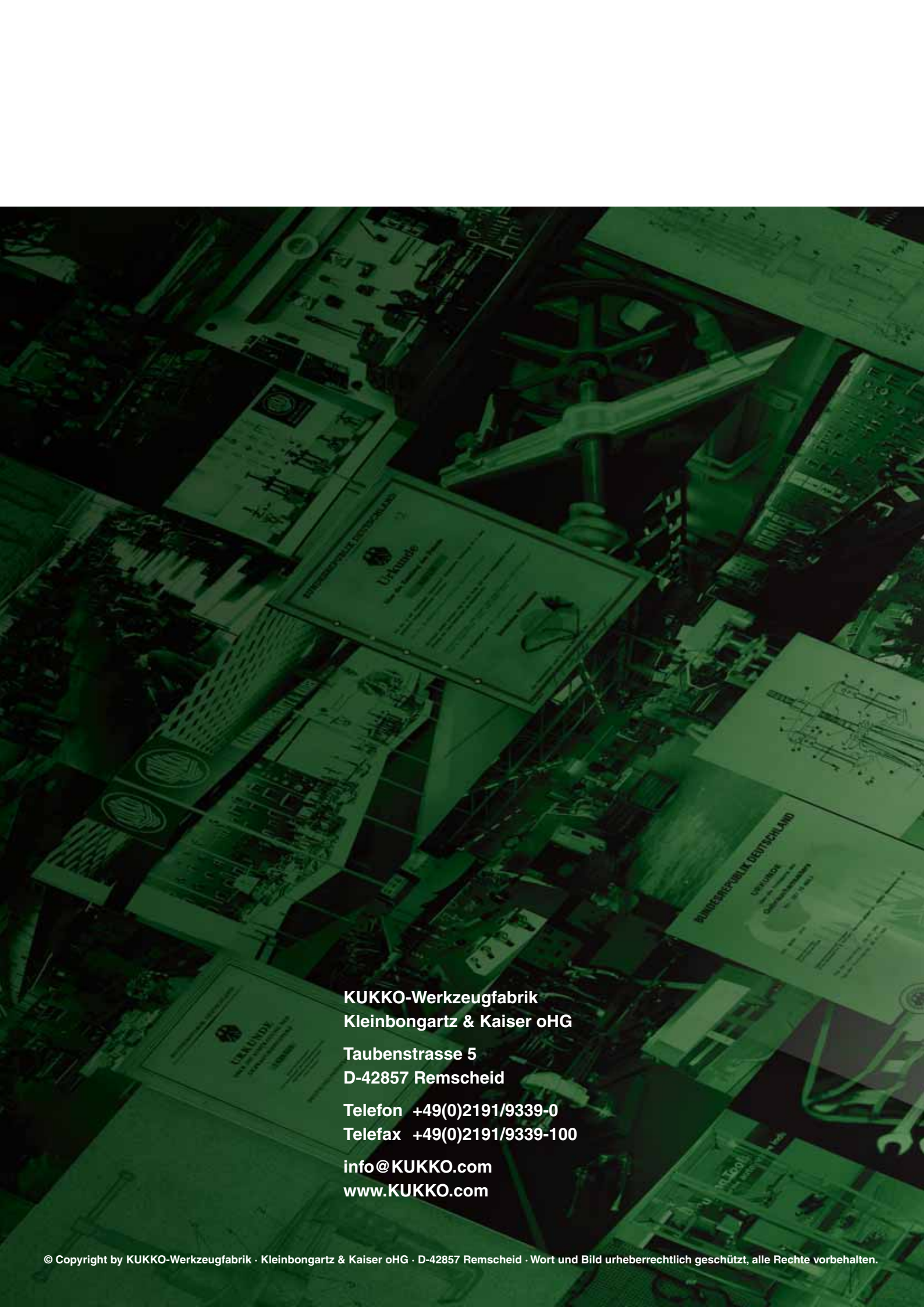

**KUKKO-Werkzeugfabrik  
Kleinbongartz & Kaiser oHG**

**Taubenstrasse 5  
D-42857 Remscheid**

**Telefon +49(0)2191/9339-0  
Telefax +49(0)2191/9339-100**

**info@KUKKO.com  
www.KUKKO.com**