

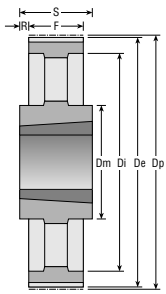

TANDREMSKIVER FOR TAPER BØSNINGER
TIMING BELT PULLEYS FOR TAPER BUSHES
ZAHNRIEMENSCHLEIBEN FÜR
TAPER BUCHSEN

Leveringsprogram	Side
Product Range	Page
Lieferprogramm	Seite
5M HTD®	46
5MR® GT®	47
8M HTD®-GT®	48
14M HTD®-GT®	50
8M Poly Chain®-GT®	52
14M Poly Chain®-GT®	54
L 3/8"	56
H 1/2"	58

Mål og materialegengivelser er med forbehold.
All dimensions and materials may be subject to change.
Mass- und Materialabweichungen vorbehalten.



Figur 7A

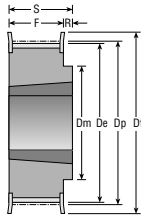

Figur 8F

Z	Rembr. Belt w. Riemenbr.	Mat.	Fig.	Best. nr. Part No. Best. Nr.	Bush	Dp	De	Df	Dm	Di	F	S	R	Vægt Weight Gewicht
34	15	ST	8F	0345M015T	1008	54,11	52,97	57	43	-	20,5	22	1,5	0,19
36	15	ST	8F	0365M015T	1108	57,30	56,16	60	44	-	20,5	22	1,5	0,20
38	15	ST	8F	0385M015T	1108	69,48	59,34	66	48	-	20,5	22	1,5	0,25
40	15	ST	8F	0405M015T	1108	63,66	62,52	71	52	-	20,5	22	1,5	0,31
44	15	ST	8F	0445M015T	1108	70,03	68,89	75	54	-	20,5	22	1,5	0,40
48	15	ST	8F	0485M015T	1210	76,39	75,25	83	64	-	20,5	25	4,5	0,45
56	15	GG	8F	0565M015T	1210	89,13	87,99	93	70	-	20,5	25	4,5	0,67
64	15	GG	8F	0645M015T	1210	101,86	100,72	106	78	-	20,5	25	4,5	0,96
72	15	GG	8F	0725M015T	1610	114,59	113,45	119	90	-	20,5	25	4,5	1,19
80	15	GG	8F	0805M015T	1610	127,32	126,18	135	92	-	20,5	25	4,5	1,57
90	15	GG	7A	0905M015T	1610	143,24	142,10	-	92	126	20,5	25	2,3	1,47
112	15	GG	7A	1125M015T	1610	178,25	177,11	-	92	162	20,5	25	2,3	1,94
136	15	GG	7A	1365M015T	2012	216,45	215,31	-	106	199	20,5	32	5,8	3,06
150	15	GG	7A	1505M015T	2012	238,73	237,59	-	106	222	20,5	32	5,8	3,90

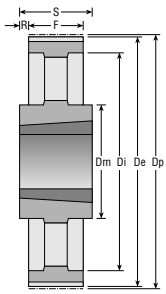

Figur 7A

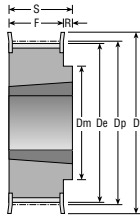

Figur 8F

Z	Rembr. Belt w. Riemenbr.	Mat.	Fig.	Best. nr. Part No. Best. Nr.	Bush	Dp	De	Df	Dm	Di	F	S	R	Vægt Weight Gewicht
34	15	ST	8F	0345MR015T	1008	54,11	52,97	57	43	-	20,5	22	1,5	0,19
36	15	ST	8F	0365MR015T	1108	57,30	56,16	60	44	-	20,5	22	1,5	0,20
38	15	ST	8F	0385MR015T	1108	69,48	59,34	66	48	-	20,5	22	1,5	0,25
40	15	ST	8F	0405MR015T	1108	63,66	62,52	71	52	-	20,5	22	1,5	0,31
44	15	ST	8F	0445MR015T	1108	70,03	68,89	75	54	-	20,5	22	1,5	0,40
48	15	ST	8F	0485MR015T	1210	76,39	75,25	83	64	-	20,5	25	4,5	0,45
56	15	GG	8F	0565MR015T	1210	89,13	87,99	93	70	-	20,5	25	4,5	0,67
64	15	GG	8F	0645MR015T	1210	101,86	100,72	106	78	-	20,5	25	4,5	0,96
72	15	GG	8F	0725MR015T	1610	114,59	113,45	119	90	-	20,5	25	4,5	1,19
80	15	GG	8F	0805MR015T	1610	127,32	126,18	135	92	-	20,5	25	4,5	1,57
90	15	GG	7A	0905MR015T	1610	143,24	142,10	-	92	126	20,5	25	2,3	1,47
112	15	GG	7A	1125MR015T	1610	178,25	177,11	-	92	162	20,5	25	2,3	1,94
136	15	GG	7A	1365MR015T	2012	216,45	215,31	-	106	199	20,5	32	5,8	3,06
150	15	GG	7A	1505MR015T	2012	238,73	237,59	-	106	222	20,5	32	5,8	3,90

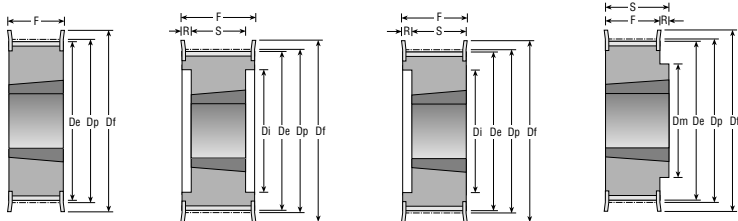

Figur 3F

Figur 4F

Figur 5F

Figur 8F

Z	Rembr. Belt w. Riemenbr.	Mat.	Fig.	Best. nr. Part No. Best. Nr.	Bush	Dp	De	Df	Dm	Di	F	S	R	Vægt Weight Gewicht
22	20	GG	5F	0228M020T	1008	56,02	54,65	60,0	-	41	28	22	6,0	0,24
	30	GG	5F	0228M030T	1008	56,02	54,65	60,0	-	41	38	22	16,0	0,29
24	20	GG	5F	0248M020T	1108	61,12	59,75	66,0	-	42	28	22	6,0	0,30
	30	GG	5F	0248M030T	1108	61,12	59,75	66,0	-	42	38	22	16,0	0,38
26	20	GG	5F	0268M020T	1108	66,21	64,84	71,0	-	46	28	22	6,0	0,36
	30	GG	5F	0268M030T	1108	66,21	64,84	71,0	-	46	38	22	16,0	0,45
28	20	GG	5F	0288M020T	1108	71,30	70,08	75,0	-	50	28	22	6,0	0,44
	30	ST	5F	0288M030T	1210	71,30	70,08	75,0	-	50	38	25	13,0	0,50
	50	ST	5F	0288M050T	1210	71,30	70,08	75,0	-	50	60	25	35,0	0,60
30	20	GG	5F	0308M020T	1108	76,39	75,13	83,0	-	58	28	22	6,0	0,53
	30	ST	3F	0308M030T	1615	76,39	75,13	83,0	-	-	38	38	-	0,55
	50	ST	5F	0308M050T	1615	76,39	75,13	83,0	-	58	60	38	22,0	0,65
32	20	GG	5F	0328M020T	1610	81,49	80,16	87,0	-	62	28	25	3,0	0,42
	30	GG	3F	0328M030T	1615	81,49	80,16	87,0	-	-	38	38	-	0,59
	50	GG	5F	0328M050T	1615	81,49	80,16	87,0	-	62	60	38	22,0	0,82
34	20	GG	5F	0348M020T	1610	86,58	85,22	91,0	-	65	28	25	3,0	0,55
	30	GG	3F	0348M030T	1615	86,58	85,22	91,0	-	-	38	38	-	0,77
	50	GG	5F	0348M050T	1615	86,58	85,22	91,0	-	65	60	38	22,0	1,06
	85	GG	4F	0348M085T	1615	86,58	85,22	91,0	-	65	95	38	28,5	1,43
36	20	GG	5F	0368M020T	1610	91,67	90,30	98,5	-	68	28	25	3,0	0,68
	30	GG	3F	0368M030T	1615	91,67	90,30	98,5	-	-	38	38	-	0,96
	50	GG	5F	0368M050T	1615	91,67	90,30	98,5	-	68	60	38	22,0	1,30
	85	GG	4F	0368M085T	1615	91,67	90,30	98,5	-	68	95	38	28,5	1,87
38	20	GG	5F	0388M020T	1610	96,77	95,39	103,0	-	72	28	25	3,0	0,80
	30	GG	3F	0388M030T	1615	96,77	95,39	103,0	-	-	38	38	-	1,15
	50	GG	3F	0388M050T	1615	96,77	95,39	103,0	-	72	60	38	22,0	1,60
	85	GG	4F	0388M085T	1615	96,77	95,39	103,0	-	72	95	38	28,5	2,20
40	20	GG	5F	0408M020T	1610	101,86	100,49	106,0	-	76	28	25	3,0	1,00
	30	GG	3F	0408M030T	1615	101,86	100,49	106,0	-	-	38	38	-	1,34
	50	GG	4F	0408M050T	2012	101,86	100,49	106,0	-	82	60	32	14,0	1,71
	85	GG	4F	0408M085T	2012	101,86	100,49	106,0	-	82	95	32	31,5	1,80
44	20	GG	8F	0448M020T	2012	112,05	110,67	119,0	93	-	28	32	4,0	1,20
	30	GG	4F	0448M030T	2012	112,05	110,67	119,0	-	91	38	32	3,0	1,33
	50	GG	4F	0448M050T	2012	112,05	110,67	119,0	-	91	60	32	14,0	1,78
	85	GG	4F	0448M085T	2012	112,05	110,67	119,0	-	91	95	32	31,5	2,30
48	20	GG	8F	0488M020T	2012	122,23	120,86	127,0	96	-	28	32	4,0	1,60
	30	GG	4F	0488M030T	2012	122,23	120,86	127,0	-	95	38	32	3,0	1,78
	50	GG	4F	0488M050T	2012	122,23	120,86	127,0	-	96	60	32	14,0	2,30
	85	GG	4F	0488M085T	2517	122,23	120,86	127,0	-	100	95	45	25,0	2,66
56	20	GG	8F	0568M020T	2012	142,60	141,23	148,0	110	-	28	32	4,0	2,40
	30	GG	4F	0568M030T	2012	142,60	141,23	148,0	-	117	38	32	3,0	3,76
	50	GG	4F	0568M050T	2517	142,60	141,23	148,0	-	116	60	45	7,5	3,40
	85	GG	4F	0568M085T	2517	142,60	141,23	148,0	-	117	95	45	25,0	4,45

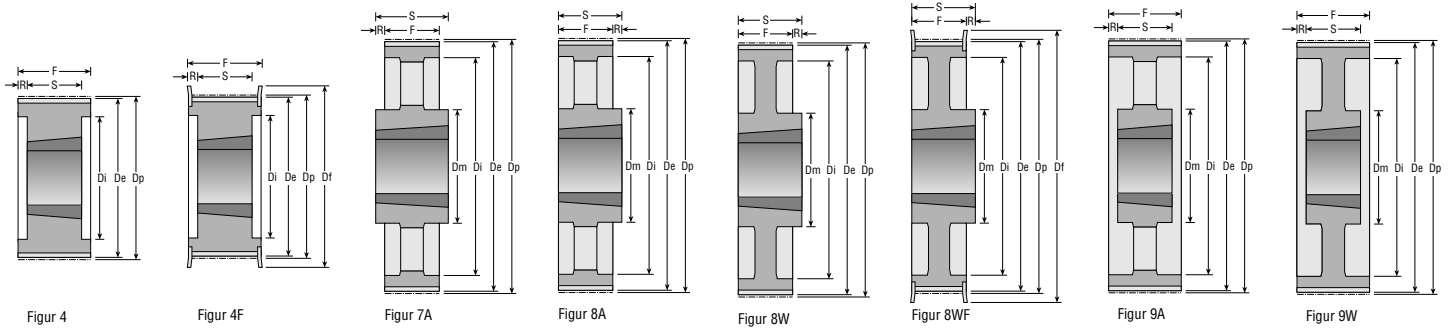

Z	Rembr. Belt w. Riemenbr.	Mat.	Fig.	Best. nr. Part No. Best. Nr.	Bush	Dp	De	Df	Dm	Di	F	S	R	Vægt Weight Gewicht
64	20	GG	8WF	0648M020T	2012	162,97	161,60	168,0	110	137	28	32	4,0	2,70
	30	GG	8F	0648M030T	2517	162,97	161,60	168,0	125	-	38	45	7,0	4,20
	50	GG	4F	0648M085T	2517	162,97	161,60	168,0	-	137	60	45	7,5	5,00
	85	GG	4F	0648M085T	2517	162,97	161,60	168,0	-	137	95	45	25,0	6,20
72	20	GG	8WF	0728M020T	2012	183,35	181,97	192,0	110	158	28	32	4,0	3,30
	30	GG	8WF	0728M030T	2517	183,35	181,97	192,0	125	158	38	45	7,0	4,30
	50	GG	4F	0728M050T	2517	183,35	181,97	192,0	125	158	60	45	7,5	6,70
	85	GG	4F	0728M085T	3020	183,35	181,97	192,0	-	158	95	51	22,0	8,00
80	20	GG	8WV	0808M020T	2012	203,72	202,35	-	110	180	28	32	4,0	3,50
	30	GG	8WV	0808M030T	2517	203,72	202,35	-	125	180	38	45	7,0	4,60
	50	GG	4	0808M050T	3020	203,72	202,35	-	-	180	60	51	4,5	8,80
	85	GG	4	0808M085T	3020	203,72	202,35	-	-	180	95	51	22,0	10,00
90	20	GG	8A	0908M020T	2012	229,18	227,81	-	110	204	28	32	4,0	3,65
	30	GG	8A	0908M030T	2517	229,18	227,81	-	125	204	38	45	7,0	5,00
	50	GG	9WV	0908M050T	3020	229,18	227,81	-	170	204	60	51	4,5	10,00
	85	GG	9WV	0908M085T	3020	229,18	227,81	-	170	204	95	51	22,0	10,80
112	30	GG	8A	1128M030T	2517	285,21	283,83	-	125	260	38	45	7,0	6,20
	50	GG	9WV	1128M050T	3020	285,21	283,83	-	170	260	60	51	4,5	12,00
	85	GG	9WV	1128M085T	3020	285,21	283,83	-	170	260	95	51	22,0	15,00
144	30	GG	8A	1448M030T	2517	366,69	365,32	-	125	341	38	45	7,0	9,00
	50	GG	9A	1448M050T	3020	366,69	365,32	-	170	341	60	51	4,5	15,20
	85	GG	9A	1448M085T	3525	366,69	365,32	-	190	341	95	65	15,0	20,00
168	50	GG	7A	1688M050T	3525	427,81	426,44	-	190	402	60	65	2,5	16,40
	85	GG	9A	1688M085T	3525	427,81	426,44	-	190	402	95	65	15,0	23,00
192	50	GG	7A	1928M050T	3525	488,92	487,55	-	190	460	60	65	2,5	21,80
	85	GG	9A	1928M085T	3525	488,92	487,55	-	190	460	95	65	15,0	28,50

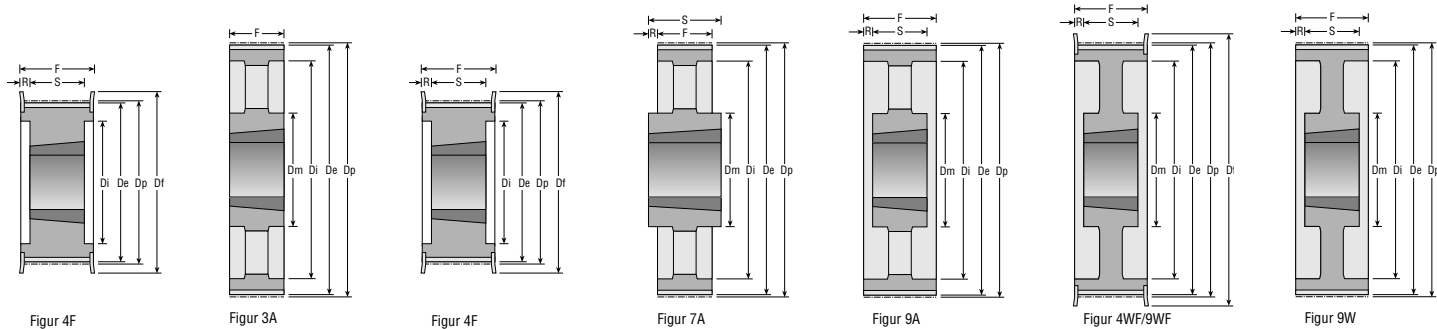

Z	Rembr. Belt w. Riemenbr.	Mat.	Fig.	Best. nr. Part No. Best. Nr.	Bush	Dp	De	Df	Dm	Di	F	S	R	Vægt Weight Gewicht
28	40	GG	4F	02814M040T	2012	124,78	122,12	127	-	98	54	32	11,0	2,07
	55	GG	4F	02814M055T	2012	124,78	122,12	127	-	98	70	32	19,0	2,20
	85	GG	4F	02814M085T	2517	124,78	122,12	127	-	98	102	45	28,5	2,70
	115	GG	4F	02814MI15T	2517	124,78	122,12	127	-	98	133	45	44,0	3,77
29	40	GG	4F	02914M040T	2012	129,23	126,57	138	-	100	54	32	11,0	2,38
	55	GG	4F	02914M055T	2012	129,23	126,57	138	-	100	70	32	19,0	2,74
	85	GG	4F	02914M085T	2517	129,23	126,57	138	-	100	102	45	28,5	3,40
	115	GG	4F	02914MI15T	2517	129,23	126,57	138	-	100	133	45	44,0	4,00
30	40	GG	4F	03014M040T	2012	133,69	130,99	138	-	100	54	32	11,0	2,65
	55	GG	4F	03014M055T	2517	133,69	130,99	138	-	100	70	45	12,5	2,70
	85	GG	4F	03014M085T	2517	133,69	130,99	138	-	100	102	45	28,5	3,75
	115	GG	4F	03014MI15T	2517	133,69	130,99	138	-	100	133	45	44,0	5,00
32	40	GG	4F	03214M040T	2012	142,60	139,88	154	-	104	54	32	11,0	3,40
	55	GG	4F	03214M055T	2517	142,60	139,88	154	-	108	70	45	12,5	3,66
	85	GG	4F	03214M085T	2517	142,60	139,88	154	-	108	102	45	28,5	4,80
	115	GG	4F	03214MI15T	2517	142,60	139,88	154	-	108	133	45	44,0	6,80
34	40	GG	4F	03414M040T	2517	151,52	148,79	160	-	110	54	45	4,5	3,87
	55	GG	4F	03414M055T	2517	151,52	148,79	160	-	110	70	45	12,5	4,55
	85	GG	4F	03414M085T	2517	151,52	148,79	160	-	110	102	45	28,5	6,00
	115	GG	4F	03414MI15T	2517	151,52	148,79	160	-	110	133	45	44,0	6,80
36	40	GG	4F	03614M040T	2517	160,43	157,68	168	-	120	54	45	4,5	4,80
	55	GG	4F	03614M055T	2517	160,43	157,68	168	-	120	70	45	12,5	5,20
	85	GG	4F	03614M085T	3020	160,43	157,68	168	-	125	102	51	25,5	5,80
	115	GG	4F	03614MI15T	3020	160,43	157,68	168	-	125	133	51	41,0	7,00
38	40	GG	4F	03814M040T	2517	169,34	166,60	183	-	130	54	45	4,5	5,40
	55	GG	4F	03814M055T	2517	169,34	166,60	183	-	130	70	45	12,5	6,20
	85	GG	4F	03814M085T	3020	169,34	166,60	183	-	130	102	51	25,5	6,80
	115	GG	4F	03814MI15T	3020	169,34	166,60	183	-	130	133	51	41,0	8,40
	170	GG	4F	03814MI170T	3030	169,34	166,60	183	-	130	187	76	55,5	11,70
40	40	GG	4F	04014M040T	2517	178,25	175,49	188	-	138	54	45	4,5	6,00
	55	GG	4F	04014M055T	2517	178,25	175,49	188	-	138	70	45	12,5	7,00
	85	GG	4F	04014M085T	3020	178,25	175,49	188	-	138	102	51	25,5	8,00
	115	GG	4F	04014MI15T	3020	178,25	175,49	188	-	140	133	51	41,0	9,20
	170	GG	4F	04014MI170T	3030	178,25	175,49	188	-	140	187	76	55,5	13,00
44	40	GG	4F	04414M040T	3020	196,08	193,28	211	-	155	54	51	1,5	7,80
	55	GG	4F	04414M055T	3020	196,08	193,28	211	-	155	70	51	9,5	8,60
	85	GG	4F	04414M085T	3030	196,08	193,28	211	-	155	102	76	13,0	11,80
	115	GG	4F	04414MI15T	3030	196,08	193,28	211	-	155	133	76	28,5	14,00
	170	GG	4F	04414MI170T	3535	196,08	193,28	211	-	155	187	89	49,0	15,00
48	40	GG	4F	04814M040T	3020	213,90	211,11	226	-	170	54	51	1,5	9,40
	55	GG	4F	04814M055T	3020	213,90	211,11	226	-	170	70	51	9,5	10,40
	85	GG	4F	04814M085T	3030	213,90	211,11	226	-	170	102	76	13,0	15,10
	115	GG	4F	04814MI15T	3030	213,90	211,11	226	-	170	133	76	28,5	17,10
	170	GG	4F	04814MI170T	3535	213,90	211,11	226	-	175	187	89	49,0	19,00



Z	Rembr. Belt w.		Fig.	Best. nr. Part No.		Bush	Dp	De	Df	Dm	Di	F	S	R	Vægt Weight	
	Riemenbr.	Mat.		Best. Nr.	Best. Nr.										Gewicht	Weight
56	40	GG	9WF	05614M040T	3020	249,55	246,76	256	170	208	54	51	1,5	10,80		
	55	GG	9WF	05614M055T	3020	249,55	246,76	256	170	208	70	51	9,5	12,00		
	85	GG	4F	05614M085T	3525	249,55	246,76	256	190	210	102	65	18,5	19,00		
	115	GG	4F	05614M115T	3535	249,55	246,76	256	-	210	133	89	22,0	24,80		
	170	GG	4F	05614M170T	3535	249,55	246,76	256	-	210	187	89	49,0	28,50		
64	40	GG	9WF	06414M040T	3020	285,21	282,41	296	170	242	54	51	1,5	13,40		
	55	GG	9WF	06414M055T	3020	285,21	282,41	296	170	242	70	51	9,5	14,50		
	85	GG	9WF	06414M085T	3525	285,21	282,41	296	190	242	102	65	18,5	23,00		
	115	GG	9WF	06414M115T	3535	285,21	282,41	296	190	242	133	89	22,0	27,00		
	170	GG	4F	06414M170T	4040	285,21	282,41	296	-	240	187	102	42,5	41,00		
72	40	GG	9W	07214M040T	3020	320,86	318,06	-	170	280	54	51	1,5	15,20		
	55	GG	9W	07214M055T	3020	320,86	318,06	-	170	280	70	51	9,5	16,20		
	85	GG	9W	07214M085T	3525	320,86	318,06	-	190	280	102	65	18,5	25,00		
	115	GG	9W	07214M115T	3535	320,86	318,06	-	190	280	133	89	22,0	29,00		
	170	GG	9W	07214M170T	4040	320,86	318,06	-	230	280	187	102	42,5	46,90		
80	40	GG	9A	08014M040T	3020	356,51	353,71	-	170	315	54	51	1,5	16,00		
	55	GG	9A	08014M055T	3020	356,51	353,71	-	170	315	70	51	9,5	17,50		
	85	GG	9A	08014M085T	3525	356,51	353,71	-	190	315	102	65	18,5	26,00		
	115	GG	9A	08014M115T	3535	356,51	353,71	-	190	315	133	89	22,0	32,00		
	170	GG	9W	08014M170T	4040	356,51	353,71	-	230	315	187	102	42,5	48,00		
90	40	GG	9A	09014M040T	3020	401,07	398,28	-	170	360	54	51	1,5	17,80		
	55	GG	9A	09014M055T	3020	401,07	398,28	-	170	360	70	51	9,5	20,10		
	85	GG	9A	09014M085T	3525	401,07	398,28	-	190	360	102	65	18,5	27,80		
	115	GG	9A	09014M115T	3535	401,07	398,28	-	190	360	133	89	22,0	36,50		
	170	GG	9A	09014M170T	4040	401,07	398,28	-	230	360	187	102	42,5	52,50		
112	40	GG	9A	11214M040T	3020	499,11	496,32	-	170	457	54	51	1,5	25,60		
	55	GG	9A	11214M055T	3020	499,11	496,32	-	170	457	70	51	9,5	28,40		
	85	GG	9A	11214M085T	3525	499,11	496,32	-	190	457	102	65	18,5	36,50		
	115	GG	9A	11214M115T	3535	499,11	496,32	-	190	457	133	89	22,0	46,00		
	170	GG	9A	11214M170T	5050	499,11	496,32	-	265	456	187	127	30,0	74,50		
144	40	GG	9A	14414M040T	3020	641,71	638,92	-	170	600	54	51	1,5	32,00		
	55	GG	9A	14414M055T	3020	641,71	638,92	-	170	600	70	51	9,5	36,20		
	85	GG	9A	14414M085T	3525	641,71	638,92	-	190	600	102	65	18,5	48,00		
	115	GG	9A	14414M115T	4040	641,71	638,92	-	230	600	133	102	15,5	68,00		
	170	GG	9A	14414M170T	5050	641,71	638,92	-	265	600	187	127	30,0	91,00		
168	40	GG	9A	16814M040T	3020	748,66	745,87	-	170	706	54	51	1,5	44,00		
	55	GG	9A	16814M055T	3020	748,66	745,87	-	170	706	70	51	9,5	49,00		
	85	GG	9A	16814M085T	3525	748,66	745,87	-	190	706	102	65	18,5	60,00		
	115	GG	9A	16814M115T	4040	748,66	745,87	-	230	706	133	102	15,5	82,60		
	170	GG	9A	16814M170T	5050	748,66	745,87	-	265	706	187	127	30,0	116,00		
192	40	GG	9A	19214M040T	3020	855,62	852,82	-	170	813	54	51	1,5	49,00		
	55	GG	9A	19214M055T	3020	855,62	852,82	-	170	813	70	51	9,5	53,00		
	85	GG	3A	19214M085T	4040	855,62	852,82	-	230	813	102	102	-	86,00		
	115	GG	9A	19214M115T	4040	855,62	852,82	-	230	813	133	102	15,5	96,00		
	170	GG	9A	19214M170T	5050	855,62	852,82	-	265	813	187	127	30,0	134,00		
216	40	GG	9A	21614M040T	3020	962,57	959,76	-	170	920	54	51	1,5	55,00		
	55	GG	7A	21614M055T	3535	962,57	959,76	-	190	920	70	89	9,5	65,80		
	85	GG	3A	21614M085T	4040	962,57	959,76	-	230	920	102	102	-	91,50		
	115	GG	9A	21614M115T	4040	962,57	959,76	-	230	920	133	102	15,5	107,00		
	170	GG	9A	21614M170T	5050	962,57	959,76	-	265	920	187	127	30,0	146,50		
238	40	GG	9A	23814M040T	3020	1060,61	1057,81	-	170	1017	54	51	1,5	-		
	55	GG	7A	23814M055T	3535	1060,61	1057,81	-	190	1017	70	89	9,5	-		
	85	GG	3A	23814M085T	4040	1060,61	1057,81	-	230	1017	102	102	-	-		
	115	GG	9A	23814M115T	4040	1060,61	1057,81	-	230	1017	133	102	15,5	-		
	170	GG	9A	23814M170T	5050	1060,61	1057,81	-	265	1017	187	127	30	-		
244	40	GG	9A	24414M040T	3020	1087,35	1084,56	-	170	1044	54	51	1,5	-		
	55	GG	7A	24414M055T	3535	1087,35	1084,56	-	190	1044	70	89	9,5	-		
	85	GG	3A	24414M085T	4040	1087,35	1084,56	-	230	1044	102	102	-	-		
	115	GG	9A	24414M115T	4040	1087,35	1084,56	-	230	1044	133	102	15,5	-		
	170	GG	9A	24414M170T	5050	1087,35	1084,56	-	265	1044	187	127	30	-		
264	40	GG	9A	26414M040T	3020	1176,47	1173,68	-	170	1133	54	51	1,5	-		
	55	GG	7A	26414M055T	3535	1176,47	1173,68	-	190	1133	70	89	9,5	-		
	85	GG	3A	26414M085T	4040	1176,47	1173,68	-	230	1133	102	102	-	-		
	115	GG	9A	26414M115T	4040	1176,47	1173,68	-	230	1133	133	102	15,5	-		
	170	GG	9A	26414M170T	5050	1176,47	1173,68	-	265	1133	187	127	30	-		

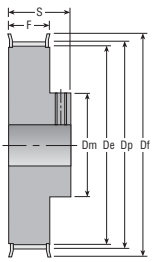

Figur 1F

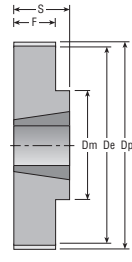

Figur 2

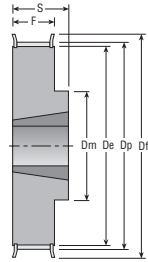

Figur 2F

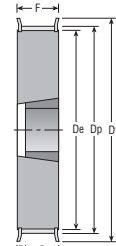

Figur 3F

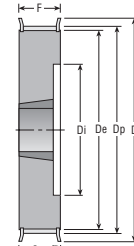

Figur 5F

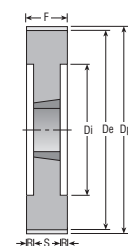

Figur 6

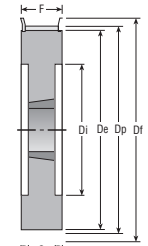

Figur 6F

Z	Rembr. Belt w. Riemenbr.	Mat.	Fig.	Best. nr. Part No. Best. Nr.	Bush	Max. boring Max. bore Max. bohrung	Dp	De	Df	Dm	Di	F	S	R	Vægt Weight Gewicht
22	12	ST	1F	8M22S12	PB12	28	56,02	54,42	62	43	-	20	30	-	0,42
	21	ST	1F	8M22S21	PB12	28*	56,02	54,42	62	43	-	30	40	-	0,57
25	12	GG	2F	8M25S12	1108	28	63,66	62,06	70	49	-	20	22	-	0,43
	21	GG	3F	8M25S21	1108	28	63,66	62,06	70	-	-	30	22	8	0,60
	36	ST	1F	8M25S36	PB12	32	63,66	62,06	70	49	-	45	55	-	1,02
28	12	GG	2F	8M28S12	1108	28	71,30	69,70	79	59	-	20	22	-	0,60
	21	ST	3F	8M28S21	1210	32	71,30	69,70	79	-	-	30	25	5	0,75
	36	ST	3F	8M28S36	1210	32	71,30	69,70	79	-	-	45	25	20	1,11
30	12	GG	2F	8M30S12	1210	32	76,39	74,79	86	66	-	20	25	-	0,67
	21	ST	3F	8M30S21	1210	32	76,39	74,79	86	-	-	30	25	5	0,83
	36	ST	3F	8M30S36	1610	42	76,39	74,79	86	-	-	45	25	20	1,22
	62	ST	1F	8M30S62	PB20	42	76,39	74,79	86	65	-	72	84	-	2,45
32	12	GG	2F	8M32S12	1610	42	81,49	79,89	90	66	-	20	25	-	0,77
	21	ST	3F	8M32S21	1610	42	81,49	79,89	90	-	-	30	25	5	0,97
	36	ST	3F	8M32S36	1610	42	81,89	79,89	90	-	-	45	25	20	1,45
	62	ST	1F	8M32S62	PB20	50*	81,49	79,89	90	69	-	72	84	-	2,82
34	12	GG	2F	8M34S12	1610	42	86,58	84,98	95	70	-	20	25	-	0,88
	21	GG	3F	8M34S21	1610	42	86,58	84,98	95	-	-	30	25	5	1,12
	36	GG	3F	8M34S36	1610	42	86,58	84,98	95	-	-	45	25	20	1,66
	62	ST	1F	8M34S62	PB20	55*	86,58	84,98	95	74	-	72	84	-	3,17
36	12	GG	2F	8M36S12	1610	42	91,67	90,07	98	78	-	20	25	-	1,02
	21	GG	3F	8M36S21	1610	42	91,67	90,07	98	-	-	30	25	5	1,29
	36	GG	3F	8M36S36	1610	42	91,67	90,07	98	-	-	45	25	20	1,90
	62	ST	1F	8M36S62	PB20	60*	91,67	90,07	98	77	-	72	84	-	3,52
38	12	GG	2F	8M38S12	1610	42	96,77	95,17	106	80	-	20	25	-	1,15
	21	GG	3F	8M38S21	1610	42	96,77	95,17	106	-	-	30	25	5	1,34
	36	GG	3F	8M38S36	1610	42	96,77	95,17	106	-	-	45	25	20	2,21
	62	ST	1F	8M38S62	PB20	60	96,77	95,17	106	84	-	72	84	-	3,91
40	12	GG	2F	8M40S12	1610	42	101,86	100,26	111	85	-	20	25	-	1,19
	21	GG	3F	8M40S21	1610	42	101,86	100,26	111	-	-	30	25	5	1,50
	36	ST	3F	8M40S36	2012	50	101,86	100,26	111	-	-	45	32	13	2,36
	62	GG	3F	8M40S62	2012	50	101,86	100,26	111	-	-	72	32	40	3,76
45	12	GG	2F	8M45S12	2012	50	114,59	112,99	119	92	-	20	32	-	1,76
	21	GG	2F	8M45S21	2012	50	114,59	112,99	119	92	-	30	32	-	2,03
	36	GG	3F	8M45S36	2012	50	114,59	112,99	119	-	-	45	32	13	3,07
	62	GG	3F	8M45S62	2012	50	114,59	112,99	119	-	-	72	32	40	4,88
48	12	GG	2F	8M48S12	2012	50	122,23	120,63	135	104	-	20	32	-	2,16
	21	GG	2F	8M48S21	2012	50	122,23	120,63	135	104	-	30	32	-	2,24
	36	GG	3F	8M48S36	2012	50	122,23	120,63	135	-	-	45	32	13	3,30
	62	GG	3F	8M48S62	2517	60	122,23	120,63	135	-	-	72	45	27	5,52

* Max. boring monteret med reduceret nothøjde

* Max. bore to be fitted with shallow key

* Max. Bohrung mit reduzierter Nothöhe montiert

FOR TAPER BØSNINGER

FOR TAPER BUSHES

FÜR TAPER BUCHSEN

8M POLY CHAIN® GT®



BI

50	12	GG	2F	8M50S12	2012	50	127,32	125,72	135	104	-	20	32	-	2,16
	21	GG	2F	8M50S21	2012	50	127,32	125,72	135	104	-	30	32	-	2,42
	36	GG	3F	8M50S36	2012	50	127,32	125,72	135	-	-	45	32	13	3,58
	62	GG	3F	8M50S62	2517	60	127,32	125,72	135	-	-	72	45	27	6,03
56	12	GG	2F	8M56S12	2012	50	142,60	141,00	151	104	-	20	32	-	2,83
	21	GG	2F	8M56S21	2012	50	142,60	141,00	151	111	-	30	32	-	3,20
	36	GG	3F	8M56S36	2517	60	142,60	141,00	151	-	-	45	45	0	4,48
	62	GG	6F	8M56S62	2517	60	142,60	141,00	151	-	111	72	45	13,5	5,43

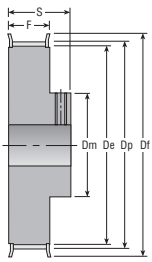

Figur 1F

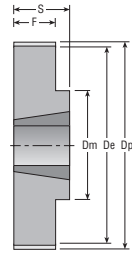

Figur 2

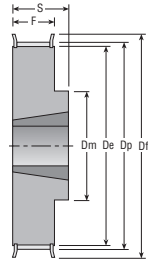

Figur 2F

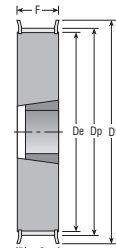

Figur 3F

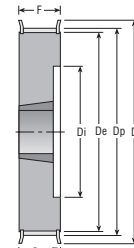

Figur 5F

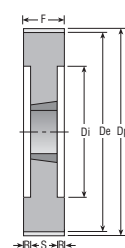

Figur 6

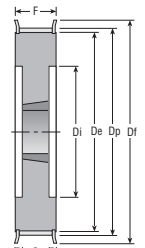

Figur 6F

Z	Rembr. Belt w. Riemenbr.	Mat.	Fig.	Best. nr. Part No. Best. Nr.	Bush	Max. boring Max. bore Max. bohrung	Dp	De	Df	Dm	Di	F	S	R	Vægt Weight Gewicht
28	20	GG	3F	I4M28S20	2012	50	124,78	121,98	141	-	-	33	32	1	2,46
	37	GG	5F	I4M28S37	2012	50	124,78	121,98	141	-	88	51	32	19	2,97
30	20	GG	3F	I4M30S20	2012	50	133,69	130,89	141	-	-	33	32	1	2,85
	37	GG	6F	I4M30S27	2517	60	133,69	130,89	141	-	98	51	45	3	3,81
32	20	GG	3F	I4M32S20	2012	50	142,60	139,80	155	-	-	33	32	1	3,26
	27	GG	6F	I4M32S37	2517	60	142,60	139,80	155	-	100	51	45	3	4,53
34	20	GG	2F	I4M34S20	2517	60	151,52	148,72	162	117	-	33	45	-	4,35
	37	GG	6F	I4M34S37	2517	60	151,52	148,72	162	-	109	51	45	3	5,06
	68	GG	1F	I4M34S68	PB40	100	151,52	148,72	162	134	-	84	104	-	6,25
36	20	GG	2F	I4M36S20	2517	60	160,43	157,53	168	117	-	33	45	-	5,05
	37	GG	5F	I4M36S37	2517	60	160,43	157,53	168	-	117	51	45	6	5,92
	68	GG	1F	I4M36S68	PB40	110*	160,43	157,53	168	134	-	84	104	-	6,68
	90	GG	1F	I4M36S90	PB50	110	160,43	157,53	168	131	-	106	136	-	8,18
38	20	GG	2F	I4M38S20	2517	60	169,34	166,54	183	117	-	33	45	-	5,39
	37	GG	5F	I4M38S37	2517	60	169,34	166,54	183	-	126	51	45	6	6,51
	68	GG	1F	I4M38S68	PB40	115*	169,34	166,54	183	141	-	84	104	-	7,46
	90	GG	1F	I4M38S90	PB50	115	169,34	166,54	183	147	-	106	136	-	9,73
	125	GG	1F	I4M38S125	PB50	115	169,34	166,54	183	147	-	141	161	-	11,74
40	20	GG	2F	I4M40S20	2517	60	178,25	175,45	197	117	-	33	45	-	5,97
	37	GG	5F	I4M40S37	2517	60	178,25	175,45	197	-	135	51	45	6	7,31
	68	GG	1F	I4M40S68	PB40	125*	178,25	175,45	197	156	-	84	104	-	7,81
	90	GG	1F	I4M40S90	PB50	125	178,25	175,45	197	156	-	106	136	-	10,29
	125	GG	1F	I4M40S125	PB50	125	178,25	175,45	197	156	-	141	161	-	12,23
44	20	GG	2F	I4M44S20	3020	75	196,08	193,28	211	144	-	33	51	-	8,03
	37	GG	3F	I4M44S37	3020	75	196,08	193,28	211	-	-	51	51	-	9,44
	68	GG	6F	I4M44S68	3020	75	196,08	193,28	211	-	153	84	51	16,5	11,54
	90	GG	1F	I4M44S90	PB50	140	196,08	193,28	211	169	-	106	136	-	11,92
	125	GG	1F	I4M44S125	PB50	140	196,08	193,28	211	170	-	141	161	-	14,46
48	20	GG	2F	I4M48S20	3020	75	213,90	211,11	226	144	-	33	51	-	9,48
	37	GG	3F	I4M48S37	3020	75	213,90	211,11	226	-	-	51	51	-	11,44
	68	GG	5F	I4M48S68	3020	75	213,90	211,11	226	-	171	84	51	33	13,74
	90	GG	6F	I4M48S90	3525	100	213,90	211,11	226	-	171	106	66	20	16,76
	125	GG	1F	I4M48S125	PB50	160	213,90	211,11	226	185	-	141	161	-	14,70
50	20	GG	2F	I4M50S20	3020	75	222,82	220,02	239	144	-	33	51	-	10,13
	37	GG	3F	I4M50S37	3020	75	222,82	220,02	239	-	-	51	51	-	12,62
	68	GG	6F	I4M50S68	3525	100	222,82	220,02	239	-	180	84	65	9,5	16,63
	90	GG	6F	I4M50S68	3525	100	222,82	220,02	239	-	180	106	66	20	18,38
	125	GG	6F	I4M50S125	3525	100	222,82	220,02	239	-	180	141	65	38	20,93
56	20	GG	9F	I4M56S20	3020	75	249,55	246,76	267	144	207	33	51	9	10,81
	37	GG	7F	I4M56S37	3020	75	249,55	246,76	267	144	207	51	51	0	12,70
	68	GG	6F	I4M56S68	3525	100	249,55	246,76	267	-	207	84	65	9,5	21,15
	90	GG	6F	I4M56S90	3525	100	249,55	246,76	267	-	207	106	66	20	23,46
	125	GG	6F	I4M56S125	3525	100	249,55	246,76	267	-	207	141	65	38	25,91

* Max. boring monteret med reduceret nothøjde

* Max. bore to be fitted with shallow key

* Max. Bohrung mit reduzierter Nothöhe montiert

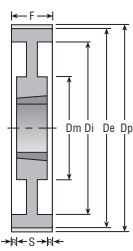

Figur 7

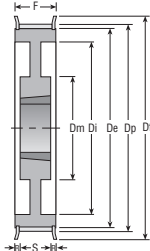

Figur 7F

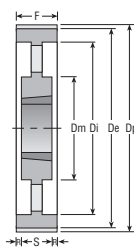

Figur 8

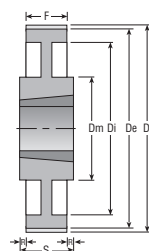

Figur 9

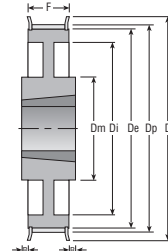

Figur 9F

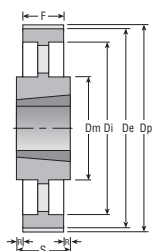

Figur 10

Z	Rembr. Belt w. Riemenbr.	Mat.	Fig.	Best. nr. Part No. Best. Nr.	Bush	Max. boring Max. bore Max. bohrung	Dp	De	Df	Dm	Di	F	S	R	Vægt Weight Gewicht
60	20	GG	9	14M60S20	3020	75	267,38	264,58	-	159	224	33	51	9	12,59
	37	GG	7	14M60S37	3020	75	267,38	264,58	-	159	224	51	51	0	14,23
	68	GG	6	14M60S68	3525	100	267,38	264,58	-	-	224	84	65	9,5	24,28
	90	GG	6	14M60S90	3525	100	267,38	264,58	-	-	224	106	66	20	26,53
	125	GG	6	14M60S125	4030	115	267,38	264,58	-	-	224	141	76	32,5	30,92
64	20	GG	9	14M64S20	3020	75	285,21	282,41	-	159	242	33	51	9	13,84
	37	GG	7	14M64S37	3020	75	285,21	282,41	-	159	242	51	51	0	15,58
	68	GG	6	14M64S68	3525	100	285,21	282,41	-	-	242	84	65	9,5	27,86
	90	GG	6	14M64S90	3525	100	285,21	282,41	-	-	242	106	66	20	30,30
	125	GG	6	14M64S125	4030	115	285,21	282,41	-	-	242	141	76	32,5	35,34
72	20	GG	9	14M72S20	3020	75	320,86	318,06	-	159	278	33	51	9	15,51
	37	GG	7	14M72S37	3020	75	320,86	318,06	-	159	278	51	51	0	17,24
	68	GG	7	14M72S68	3525	100	320,86	318,06	-	178	278	84	65	9,5	25,74
	90	GG	7	14M72S90	3525	100	320,86	318,06	-	178	278	106	66	20	26,36
	125	GG	7	14M72S125	4030	115	320,86	318,06	-	215	278	141	76	32,5	37,71
80	20	GG	9	14M80S20	3020	75	356,51	353,71	-	159	314	33	51	9	18,13
	37	GG	7	14M80S37	3020	75	356,51	353,71	-	159	314	51	51	0	20,32
	68	GG	7	14M80S68	3525	100	356,51	353,71	-	178	314	84	65	9,5	29,86
	90	GG	7	14M80S90	4030	115	356,51	353,71	-	215	314	106	76	15	35,61
	125	GG	7	14M80S125	4030	115	356,51	353,71	-	215	314	141	76	32,5	42,02
90	20	GG	10	14M90S20	3020	75	401,07	398,27	-	159	360	33	51	9	19,47
	37	GG	8	14M90S37	3020	75	401,07	398,27	-	159	360	51	51	0	29,85
	68	GG	8	14M90S68	3525	100	401,07	398,27	-	178	360	84	65	9,5	31,24
	90	GG	7	14M90S90	4030	115	401,07	398,27	-	215	360	106	76	15	41,90
	125	GG	7	14M90S125	4030	115	401,07	398,27	-	215	360	141	76	32,5	51,29
112	20	GG	10	14M112S20	3020	75	499,11	496,31	-	159	456	33	51	9	24,25
	37	GG	8	14M112S37	3020	75	499,11	496,31	-	159	456	51	51	0	27,43
	68	GG	8	14M112S68	3525	100	499,11	496,31	-	178	456	84	65	9,5	39,25
	90	GG	8	14MS11290	4535	125	499,11	496,31	-	215	456	106	90	8	70,89
	125	GG	8	14M112S125	4535	125	499,11	496,31	-	215	581	141	89	26	65,64
140	20	GG	10	14M140S20	3020	75	623,89	621,09	-	159	581	33	51	9	20,96
	37	GG	10	14M140S37	3525	100	623,89	621,09	-	206	581	51	65	7	33,55
	68	GG	8	14M140S68	3525	100	623,89	621,09	-	206	581	84	65	9,5	40,87
	90	GG	8	14M140S90	4535	125	623,89	621,09	-	215	581	106	90	8	74,56
	125	GG	8	14M140S125	4535	125	623,89	621,09	-	215	581	141	89	26	67,90
168	37	GG	10	14M168S37	3525	100	748,66	745,87	-	206	706	51	65	7	64,50
	68	GG	8	14M168S68	3525	100	748,66	745,87	-	206	706	84	65	9,5	73,30
	90	GG	8	14M168S90	5040	130*	748,66	745,87	-	267	708	106	102	2	109,24
	125	GG	8	14M168S125	5040	125	748,66	745,87	-	267	706	141	102	19,5	120,66
192	37	GG	10	14M192S37	4030	115	855,61	852,82	-	215	812	51	76	12,5	83,82
	68	GG	8	14M192S68	4030	115	855,61	852,82	-	215	812	84	76	4	94,21
	90	GG	8	14M192S90	5040	130*	855,61	852,82	-	267	812	106	102	2	126,05
	125	GG	8	14M192S125	5040	125	855,61	852,82	-	267	812	141	102	19,5	142,39

PB = Forboret
PB = Min. plain bore
PB = Vorgebohrt



BI

L**3/8" (9,525 mm)**

FOR TAPER BØSNINGER
FOR TAPER BUSHES
FÜR TAPER BUCHSEN

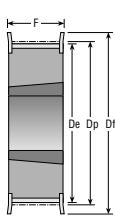

Figur 3F

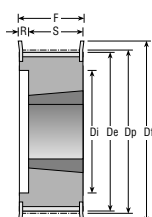

Figur 5F

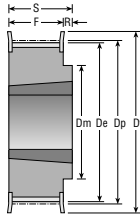

Figur 8F

Z	Rembr. Belt w. Riemerbr.	Mat.	Fig.	Best. nr. Part No. Best. Nr.	Bush	Dp	De	Df	Dm	Di	F	S	R	Vægt Weight Gewicht
18	50	ST	8F	018L050T	1108	54,57	53,81	60	44	-	19	22	3,0	0,2
	75	ST	3F	018L075T	1108	54,57	53,81	60	-	-	25	25	-	0,2
	100	ST	5F	018L100T	1108	54,57	53,81	60	-	38	31	22	9,0	0,2
19	50	ST	8F	019L050T	1108	57,61	56,84	60	44	-	19	22	3,0	0,2
	75	ST	3F	019L075T	1108	57,61	56,84	60	-	-	25	25	-	0,3
	100	ST	5F	019L100T	1108	57,61	56,84	60	-	38	31	22	9,0	0,3
20	50	ST	8F	020L050T	1108	60,64	59,88	66	48	-	19	22	3,0	0,2
	75	ST	3F	020L075T	1108	60,64	59,88	66	-	-	25	25	-	0,3
	100	ST	5F	020L100T	1108	60,64	59,88	66	-	45	31	22	9,0	0,4
21	50	ST	8F	021L050T	1108	63,67	62,91	71	48	-	19	22	3,0	0,3
	75	ST	3F	021L075T	1108	63,67	62,91	71	-	-	25	25	-	0,4
	100	ST	5F	021L100T	1108	63,67	62,91	71	-	47	31	22	9,0	0,4
22	50	ST	8F	022L050T	1108	66,70	65,94	75	51	-	19	22	3,0	0,3
	75	ST	3F	022L075T	1108	66,70	65,94	75	-	-	25	25	-	0,4
	100	ST	5F	022L100T	1108	66,70	65,94	75	-	51	31	22	9,0	0,4
23	50	GG	8F	023L050T	1108	69,73	68,97	79	54	-	19	22	3,0	0,4
	75	GG	3F	023L075T	1108	69,73	68,97	79	-	-	25	25	-	0,4
	100	GG	5F	023L100T	1108	69,73	68,97	79	-	54	32	22	10,0	0,5
24	50	GG	8F	024L050T	1108	72,77	72,00	79	54	-	19	22	3,0	0,4
	75	GG	3F	024L075T	1108	72,77	72,00	79	-	-	25	25	-	0,5
	100	GG	5F	024L100T	1108	72,77	72,00	79	-	54	32	22	10,0	0,6
25	50	GG	8F	025L050T	1108	75,80	75,04	83	56	-	19	22	3,0	0,5
	75	GG	3F	025L075T	1108	75,80	75,04	83	-	-	25	25	-	0,6
	100	GG	5F	025L100T	1108	75,80	75,04	83	-	56	32	22	10,0	0,6
26	50	GG	8F	026L050T	1108	78,83	78,07	87	60	-	19	22	3,0	0,5
	75	GG	3F	026L075T	1108	78,83	78,07	87	-	-	25	25	-	0,6
	100	GG	5F	026L100T	1108	78,83	78,07	87	-	60	32	22	10,0	0,7
27	50	GG	8F	027L050T	1108	81,86	81,10	87	65	-	19	22	3,0	0,6
	75	GG	3F	027L075T	1108	81,86	81,10	87	-	-	25	25	-	0,7
	100	GG	5F	027L100T	1108	81,86	81,10	87	-	62	32	22	10,0	0,8
28	50	GG	8F	028L050T	1108	84,89	84,13	91	65	-	19	22	3,0	0,6
	75	GG	3F	028L075T	1108	84,89	84,13	91	-	-	25	25	-	0,7
	100	GG	5F	028L100T	1108	84,89	84,13	91	-	65	32	22	10,0	0,8
30	50	GG	8F	030L050T	1108	90,96	90,20	97	70	-	19	22	3,0	0,8
	75	GG	3F	030L075T	1108	90,96	90,20	97	-	-	25	25	-	0,9
	100	GG	5F	030L100T	1210	90,96	90,20	97	-	71	32	25	7,0	0,9
32	50	GG	8F	032L050T	1108	97,02	96,26	103	74	-	19	22	3,0	0,9
	75	GG	3F	032L075T	1108	97,02	96,26	103	-	-	25	25	-	1,0
	100	GG	5F	032L100T	1210	97,02	96,26	103	-	75	32	25	7,0	1,0
36	50	GG	8F	036L050T	1108	109,15	108,39	115	87	-	19	22	3,0	1,2
	75	GG	3F	036L075T	1610	109,15	108,39	115	-	-	25	25	-	1,2
	100	GG	5F	036L100T	1610	109,15	108,39	115	-	89	32	25	7,0	1,4
40	50	GG	8F	040L050T	1610	121,28	120,51	127	97	-	19	25	6,0	1,5
	75	GG	3F	040L075T	1610	121,28	120,51	127	-	-	25	25	-	1,7
	100	GG	5F	040L100T	1610	121,28	120,51	127	-	101	32	25	7,0	1,7

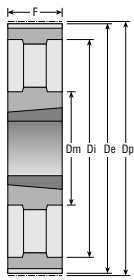

Figur 3A

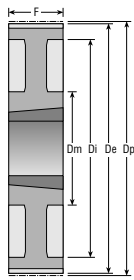

Figur 3W

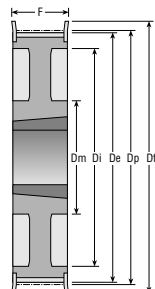

Figur 3WF

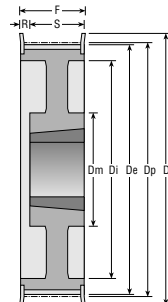

Figur 5WF

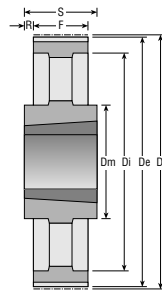

Figur 7A

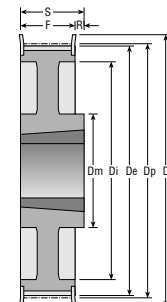

Figur 8WF

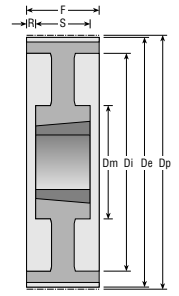

Figur 9W

Z	Rembr. Belt w. Riemenbr.	Mat.	Fig.	Best. nr. Part No. Best. Nr.	Bush	Dp	De	Df	Dm	Di	F	S	R	Vægt Weight Gewicht
48	50	GG	8WF	048L050T	1610	145,53	144,77	152	88	124	19	25	6,0	2,3
	75	GG	3WF	048L075T	1610	145,53	144,77	152	92	124	25	25	-	2,5
	100	GG	5WF	048L100T	1610	145,53	144,77	152	92	124	32	25	7,0	2,7
60	50	GG	7A	060L050T	1610	181,91	181,15	-	92	166	19	25	3,0	2,0
	75	GG	3W	060L075T	1610	181,91	181,15	-	92	166	25	25	-	3,0
	100	GG	9W	060L100T	1610	181,91	181,15	-	92	166	32	25	3,5	2,4
72	50	GG	7A	072L050T	1610	218,30	217,53	-	92	202	19	25	3,0	3,0
	75	GG	3A	072L075T	1610	218,30	217,53	-	92	202	25	25	-	4,0
	100	GG	3A	072L100T	2012	218,30	217,53	-	106	202	32	32	-	4,4
84	50	GG	7A	084L050T	1610	254,68	253,92	-	92	236	19	25	3,0	4,0
	75	GG	7A	084L075T	2012	254,68	253,92	-	106	236	25	32	3,5	5,2
	100	GG	3A	084L100T	2012	254,68	253,92	-	106	236	32	32	-	6,0
96	50	GG	7A	096L050T	2012	291,06	290,30	-	106	270	19	32	6,5	5,5
	75	GG	7A	096L075T	2012	291,06	290,30	-	106	270	25	32	3,5	6,5
	100	GG	3A	096L100T	2012	291,06	290,30	-	106	270	32	32	-	7,1
120	50	GG	7A	120L050T	2012	363,83	363,07	-	106	343	19	32	6,5	6,8
	75	GG	7A	120L075T	2012	363,83	363,07	-	106	343	25	32	3,5	7,6
	100	GG	3A	120L100T	2012	363,83	363,07	-	106	343	32	32	-	8,5



H

BI

1/2" (12,7 mm)

FOR TAPER BØSNINGER FOR TAPER BUSHES FÜR TAPER BUCHSEN

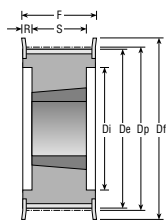

Figur 4F

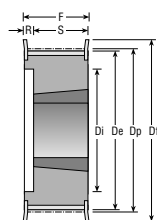

Figur 5F

Z	Rembr. Belt w. Riembr.	Mat.	Fig.	Best. nr. Part No. Best. Nr.	Bush	Dp	De	Df	Dm	Di	F	S	R	Vægt Weight Gewicht
16	100	ST	5F	016H100T	1108	64,68	63,31	71	-	45	31	22	9,0	0,4
18	100	ST	5F	018H100T	1210	72,77	71,39	79	-	52	31	25	6,0	0,5
	150	ST	5F	018H150T	1210	72,77	71,39	79	-	53	45	25	20,0	0,6
	200	ST	5F	018H200T	1210	72,77	71,39	79	-	52	58	25	33,0	0,8
19	100	ST	5F	019H100T	1210	76,81	75,44	83	-	56	31	25	6,0	0,6
	150	ST	5F	019H150T	1210	76,81	75,44	83	-	56	45	25	20,0	0,7
	200	ST	5F	019H200T	1610	76,81	75,44	83	-	56	58	25	33,0	0,9
20	100	ST	5F	020H100T	1210	80,55	79,48	87	-	60	31	25	6,0	0,7
	150	ST	5F	020H150T	1210	80,55	79,48	87	-	60	45	25	20,0	0,8
	200	ST	5F	020H200T	1610	80,55	79,48	87	-	60	58	25	33,0	1,0
	300	ST	4F	020H300T	1615	80,55	79,48	87	-	65	84	38	23,0	1,5
21	100	GG	5F	021H100T	1210	84,89	83,52	91	-	63	32	25	7,0	0,8
	150	GG	5F	021H150T	1210	84,89	83,52	91	-	64	45	25	20,0	1,0
	200	GG	5F	021H200T	1610	84,89	83,52	91	-	64	58	25	33,0	1,7
	300	GG	4F	021H300T	1615	84,89	83,52	91	-	66	84	38	23,0	1,2
22	100	GG	5F	022H100T	1210	88,94	87,56	93	-	67	32	25	7,0	0,9
	150	GG	5F	022H150T	1210	88,94	87,56	93	-	68	45	25	20,0	1,2
	200	GG	5F	022H200T	1610	88,94	87,56	93	-	68	58	25	33,0	1,5
	300	GG	4F	022H300T	1615	88,94	87,56	93	-	67	84	38	23,0	1,6
23	100	GG	5F	023H100T	1610	92,98	91,61	97	-	71	32	25	7,0	0,9
	150	GG	5F	023H150T	1610	92,98	91,61	97	-	71	45	25	20,0	1,3
	200	GG	5F	023H200T	1610	92,98	91,61	97	-	71	58	25	33,0	1,8
	300	GG	4F	023H300T	1615	92,98	91,61	97	-	71	84	38	23,0	1,8
24	100	GG	5F	024H100T	1610	97,02	95,65	103	-	75	32	25	7,0	1,0
	150	GG	5F	024H150T	1610	97,02	95,65	103	-	74	45	25	20,0	1,2
	200	GG	5F	024H200T	1610	97,02	95,65	103	-	74	58	25	33,0	1,5
	300	GG	4F	024H300T	1615	97,02	95,65	103	-	75	84	38	23,0	2,1
25	100	GG	5F	025H100T	1610	101,06	99,69	106	-	79	32	25	7,0	1,0
	150	GG	5F	025H150T	1610	101,06	99,69	106	-	78	45	25	20,0	1,2
	200	GG	5F	025H200T	1610	101,06	99,69	106	-	78	58	25	33,0	1,5
	300	GG	4F	025H300T	1615	101,06	99,69	106	-	79	84	38	23,0	2,0
26	100	GG	5F	026H100T	1610	105,11	103,73	111	-	83	32	25	7,0	1,2
	150	GG	5F	026H150T	1610	105,11	103,73	111	-	82	45	25	20,0	1,4
	200	GG	5F	026H200T	1610	105,11	103,73	111	-	82	58	25	33,0	1,8
	300	GG	4F	026H300T	1615	105,11	103,73	111	-	83	84	38	23,0	2,7
27	100	GG	5F	027H100T	1610	109,15	107,78	115	-	87	32	25	7,0	1,3
	150	GG	5F	027H150T	1610	109,15	107,78	115	-	87	45	25	20,0	1,6
	200	GG	5F	027H200T	1610	109,15	107,78	115	-	87	58	25	33,0	1,9
	300	GG	4F	027H300T	2012	109,15	107,78	115	-	87	84	32	26,0	3,0
28	100	GG	5F	028H100T	1610	113,19	111,82	119	-	91	32	25	7,0	1,5
	150	GG	5F	028H150T	1610	113,19	111,82	119	-	91	45	25	20,0	1,8
	200	GG	5F	028H200T	1610	113,19	111,82	119	-	91	58	25	33,0	1,9
	300	GG	4F	028H300T	2012	113,19	111,82	119	-	91	84	32	26,0	2,4

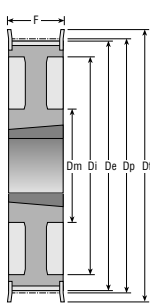

Figur 3WF

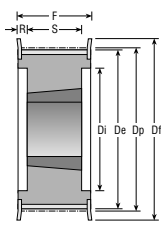

Figur 4F

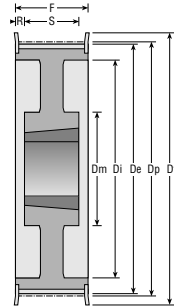

Figur 4WF/9WF

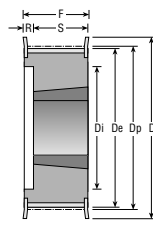

Figur 5F

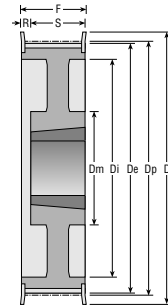

Figur 5WF

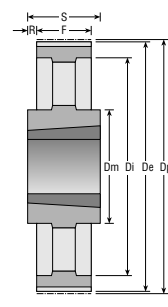

Figur 7A

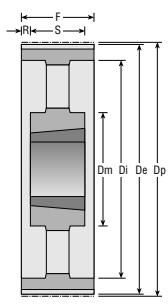

Figur 9A

Z	Rembr. Belt w. Riemenbr.	Mat.	Fig.	Best. nr. Part No. Best. Nr.	Bush	Dp	De	Df	Dm	Di	F	S	R	Vægt Weight Gewicht
30	100	GG	5F	030H100T	1610	121,28	119,90	127	-	99	32	25	7,0	1,7
	150	GG	5F	030H150T	1610	121,28	119,90	127	-	99	45	25	20,0	2,0
	200	GG	5F	030H200T	1610	121,28	119,90	127	-	99	58	25	33,0	2,3
	300	GG	4F	030H300T	2012	121,28	119,90	127	-	99	84	32	26,0	2,9
32	100	GG	5WF	032H100T	1610	129,36	127,99	135	92	108	32	25	7,0	2,0
	150	GG	5WF	032H150T	1610	129,36	127,99	135	92	108	45	25	20,0	2,3
	200	GG	5F	032H200T	2012	129,36	127,99	135	-	107	58	32	26,0	3,0
	300	GG	4F	032H300T	2517	129,36	127,99	135	-	107	84	45	19,5	3,3
36	100	GG	5WF	036H100T	1610	145,53	144,16	152	92	124	32	25	7,0	2,7
	150	GG	5WF	036H150T	1610	145,53	144,16	152	92	124	45	25	20,0	3,1
	200	GG	5WF	036H200T	2012	145,53	144,16	152	102	124	58	32	26,0	3,0
	300	GG	4F	036H300T	2517	145,53	144,16	152	-	124	84	45	19,5	4,5
40	100	GG	5WF	040H100T	1610	161,70	160,33	168	92	140	32	25	7,0	3,6
	150	GG	5WF	040H150T	1610	161,70	160,33	168	92	140	45	25	20,0	4,0
	200	GG	5WF	040H200T	2012	161,70	160,33	168	106	140	58	32	26,0	3,6
	300	GG	4F	040H300T	2517	161,70	160,33	168	-	137	84	45	19,5	6,0
44	100	GG	3WF	044H100T	2012	177,87	176,50	184	106	153	32	32	-	3,8
	150	GG	5WF	044H150T	2012	177,87	176,50	184	106	153	45	32	13,0	3,6
	200	GG	5WF	044H200T	2012	177,87	176,50	184	106	153	58	32	26,0	4,5
	300	GG	4WF	044H300T	2517	177,87	176,50	184	119	153	86	45	20,5	6,6
48	100	GG	3WF	048H100T	2012	194,04	192,67	200	106	169	32	32	-	3,2
	150	GG	5WF	048H150T	2012	194,04	192,67	200	106	169	45	32	13,0	4,8
	200	GG	5WF	048H200T	2517	194,04	192,67	200	119	169	58	45	13,0	4,6
	300	GG	4WF	048H300T	2517	194,04	192,67	200	119	169	86	45	20,5	7,6
60	100	GG	9A	060H100T	2012	242,55	241,18	-	106	223	34	32	1,0	4,8
	150	GG	9A	060H150T	2012	242,55	241,18	-	106	223	46	32	7,0	5,4
	200	GG	9A	060H200T	2517	242,55	241,18	-	119	223	60	45	7,5	7,0
	300	GG	9A	060H300T	2517	242,55	241,18	-	119	223	86	45	20,5	8,4
72	100	GG	9A	072H100T	2012	291,06	289,69	-	106	270	34	32	1,0	5,7
	150	GG	9A	072H150T	2012	291,06	289,69	-	106	270	46	32	7,0	6,5
	200	GG	9A	072H200T	2517	291,06	289,69	-	119	270	60	45	7,5	8,0
	300	GG	9A	072H300T	2517	291,06	289,69	-	119	270	86	45	20,5	10,4
84	100	GG	9A	084H100T	2012	339,57	338,20	-	106	318	34	32	1,0	6,8
	150	GG	9A	084H150T	2012	339,57	338,20	-	106	320	46	32	7,0	8,4
	200	GG	9A	084H200T	2517	339,57	338,20	-	119	320	60	45	7,5	9,0
	300	GG	9A	084H300T	2517	339,57	338,20	-	119	320	86	45	20,5	12,5
96	100	GG	7A	096H100T	2517	388,08	386,71	-	119	366	34	45	5,5	8,2
	150	GG	9A	096H150T	2517	388,08	386,71	-	119	366	46	45	0,5	10,2
	200	GG	9A	096H200T	2517	388,08	386,71	-	119	366	60	45	7,5	11,5
	300	GG	9A	096H300T	3030	388,08	386,71	-	150	362	86	76	5,0	14,2
120	100	GG	7A	120H100T	2517	485,10	483,73	-	119	462	34	45	5,5	12,1
	150	GG	9A	120H150T	2517	485,10	483,73	-	119	462	46	45	0,5	13,5
	200	GG	9A	120H200T	2517	485,10	483,73	-	119	462	60	45	7,5	15,4
	300	GG	9A	120H300T	3030	485,10	483,73	-	150	460	86	76	5,0	18,8

